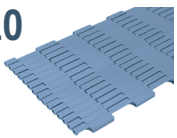
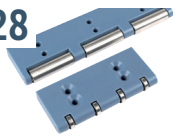
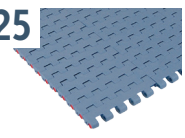

510 

510 FT
Pag 170

228 

228 Transfer plate
Pag 179

525 

525 HD FT
Pag 187

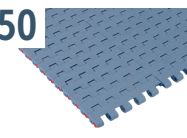
550 

550 FT
Pag 199

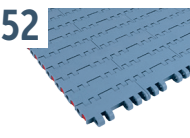
552 

552 FT
Pag 215

228 with Rollers
Pag 179

525 FTT
Pag 188

550 FT One track Belt
Pag 200

552 FT One track Belt
Pag 216

228 with Bearings
Pag 180

525 HD FG
Pag 189

550 FTT
Pag 201

552 FTT
Pag 217

228 with Positioner and Bearings
Pag 181

525 HD GT
Pag 190

550 FG
Pag 202

552 PT
Pag 218

228 for Micropitch
Pag 181

525 HD GT Side indent
Pag 191

550 FG One track Belt
Pag 203

552 PT One track Belt
Pag 219

550 GT
Pag 204

552 GT
Pag 220

550 GT Side indent
Pag 205

552 GT Side indent
Pag 221

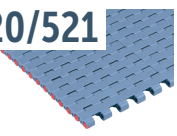
520/521 

520 FT
Pag 172

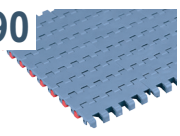
590 

590 FT
Pag 183

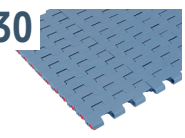
530 

530 FT
Pag 193

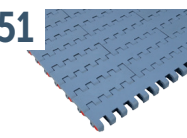
551 

551 FT
Pag 207

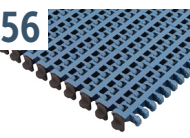
556 

556 FT
Pag 223

520 FTT
Pag 173

590 FT One track Belt
Pag 184

530 FTT
Pag 194

551 FTT
Pag 208

556 GT
Pag 224

520 FG
Pag 174

590 FTT
Pag 185

530 GT
Pag 195

551 GT
Pag 209

520 GT
Pag 175

530 GT Side indent
Pag 196

551 GT Side indent
Pag 210

520 LBP
Pag 176

530 LBP
Pag 197

551 LBP
Pag 211

520 M
Pag 177

551 PRO LBP
Pag 212/213

521 FT
Pag 178

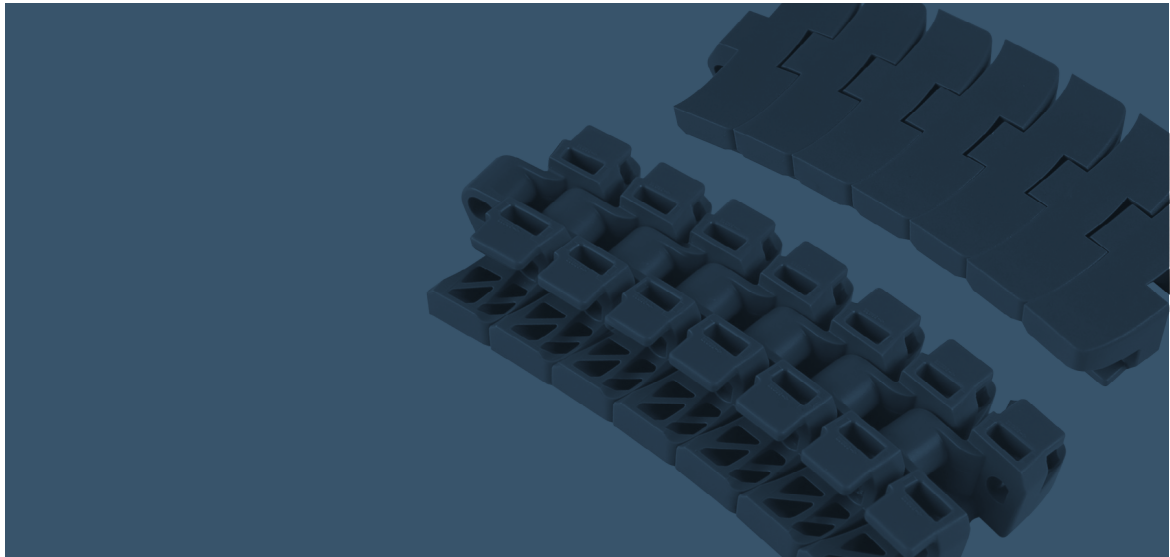

600

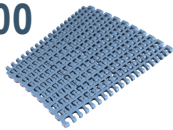

600 Standard
Pag 226

600 Heavy duty
Pag 227

600 Heavy duty with Bearings
Pag 228

600 Small radius
Pag 229

600 Heavy duty/ Small radius
Pag 230

600 Heavy duty/ Small radius with Bearings
Pag 231

600 with pusher
Pag 232

1047 Heavy duty guide
Pag 232

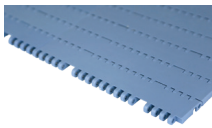

ZERO CONTACT
Pag 234/235

500

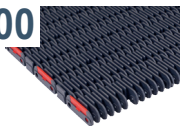

500 RR
Pag 236

389

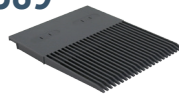

389 Combs
Pag 237

260



260 M FT
Pag 239

260 M FG
Pag 240

260 TAB
Pag 241

261

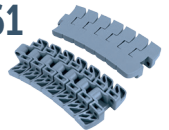

261 M FT
Pag 242

261 M TAB
Pag 243

510 Series

510

Pitch 8 mm
H= 6 mm



510 FT

Movex[®]

510 FT

Tappeti modulari / Modular belts / Mattenketten

Imperial Size

510 FT

Tappeto Modulare 510 FT, H=6 M=3"
Modular Belt Series 510 FT, H=6 M=3" / Modulare Mattenkette 510 FT, H=6 M=3"

CODE STRUCTURE GUIDE			
(Example)			
5331	01	0012	A
Series	*Material	Width	Version

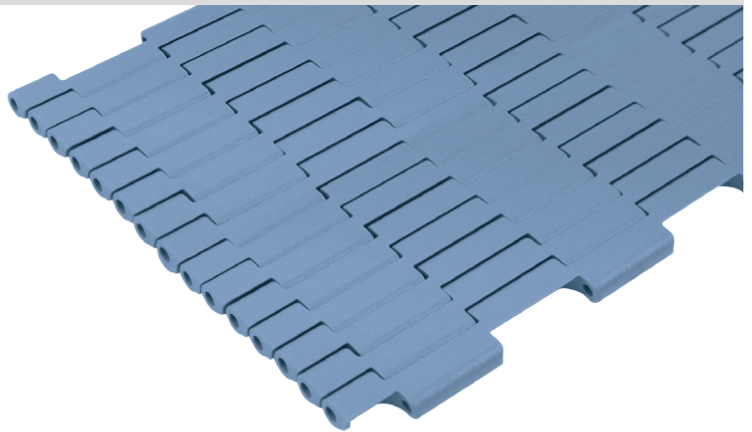
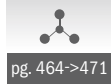

*Material

LFA - Code 01

Low friction Acetal

Max w. load: 3000 N/m
Weight: 5,8 kg/m²
Temp. range: dry -40÷80 °C
wet -40÷65 °C
Pin material: PBT white

MX - Code 03

Performance PBT

Max w. load: 2700 N/m
Weight: 5,5 kg/m²
Temp. range: dry -40÷120 °C
wet -40÷60 °C
Pin material: POM grey

Version A - Standard

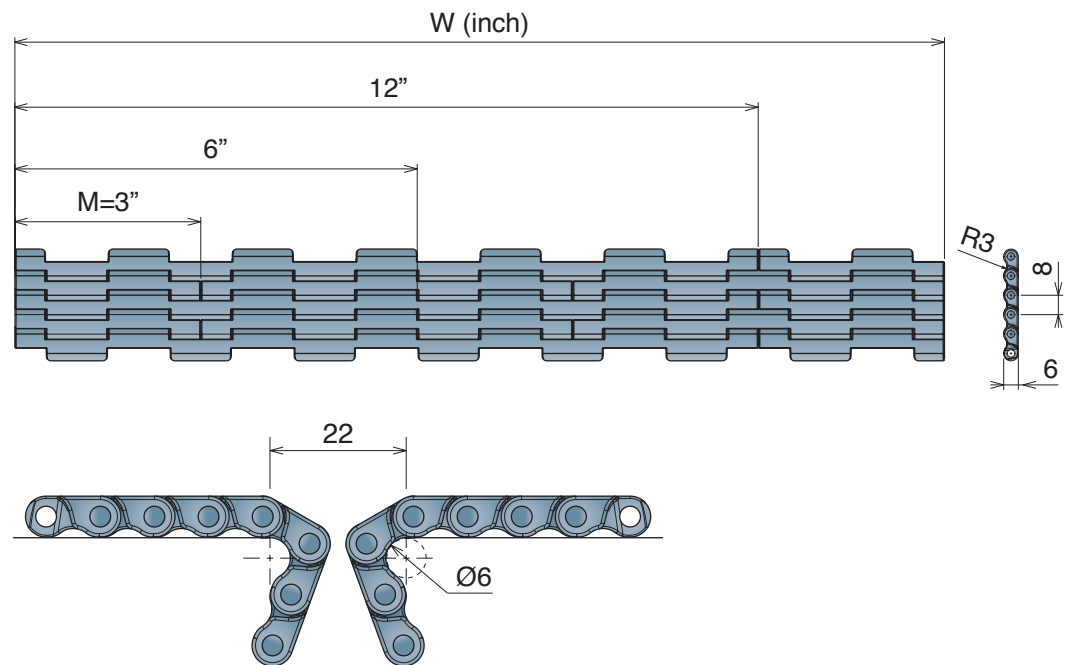

Version A - Standard

Series	Material	Width	Version
5331	*	0003	A
5331	*	0006	A
5331	*	0009	A
5331	*	0012	A
5331	*	0015	A
5331	*	0018	A
5331	*	0021	A
5331	*	0024	A

Tappeti modulari / Modular belts / Mattenketten

520/521

Pitch 12,7 mm

H= 8,7 mm

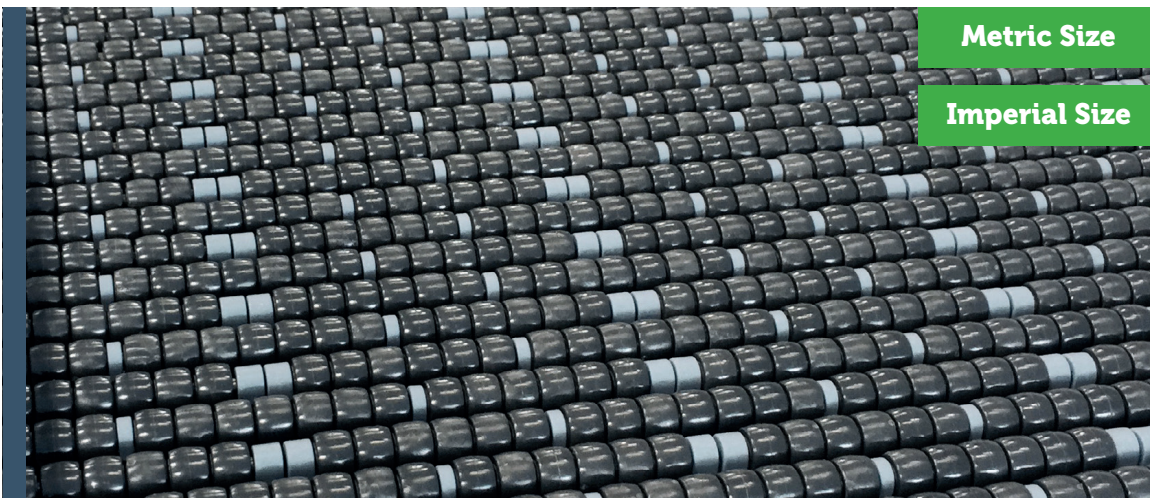

Metric Size

Imperial Size

520 FT

520 FTT

520 FG

520 GT

520 LBP

520 M

521 FT

288 *Transfer plate*

288 *with Rollers*

288 *with Bearings*

288 *with Positioner and Bearings*

288 *For Micropitch*

520 FT

Tappeto Modulare 520 FT, H=8,7 M=85
Modular Belt Series 520 FT, H=8,7 M=85 / Modulare Mattenkette 520 FT, H=8,7 M=85

CODE STRUCTURE GUIDE			
(Example)			
5201	03	0340	C
Series	*Material	Width	Version

Backflex radius min.: 10 mm

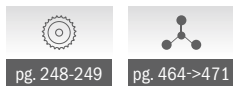

pg. 248-249

pg. 464->471

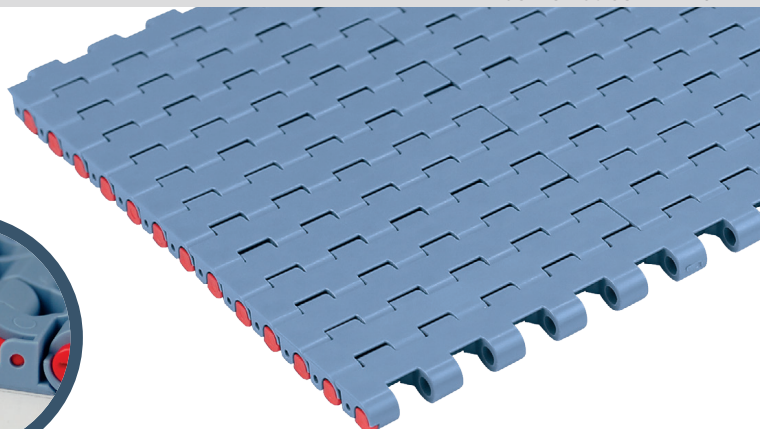
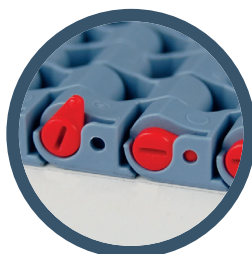

*Material

LFA - Code 01

Low friction Acetal

Max w. load: 21500 N/m
Weight: 7,8 kg/m²
Temp. range dry: -40+80 °C
Temp. range wet: -40+65 °C
Pin material: PBT white

PP - Code 02

Polypropylene

Max w. load: 13000 N/m
Weight: 7,5 kg/m²
Temp. range dry: 4+80 °C
Temp. range wet: 4+65 °C
Pin material: PP blu

MX - Code 03

Performance PBT

Max w. load: 17500 N/m
Weight: 7,5 kg/m²
Temp. range dry: -40+120 °C
Temp. range wet: -40+60 °C
Pin material: POM grey

DKM - Code 16

Aramid Reinforced Acetal

Max w. load: 21500 N/m
Weight: 7,8 kg/m²
Temp. range dry: -40+80 °C
Temp. range wet: -40+65 °C
Pin material: PBT white

MWX - Code 17

Polyamide Composite

Max w. load: 21500 N/m
Weight: 8,1 kg/m²
Temp. range dry: -40+104 °C
Temp. range wet: NR
Pin material: PBT white

MPX - Code 25

Lubricated Acetal

Max w. load: 21500 N/m
Weight: 7,8 kg/m²
Temp. range dry: -40+80 °C
Temp. range wet: -40+65 °C
Pin material: PBT white

Version A - Standard

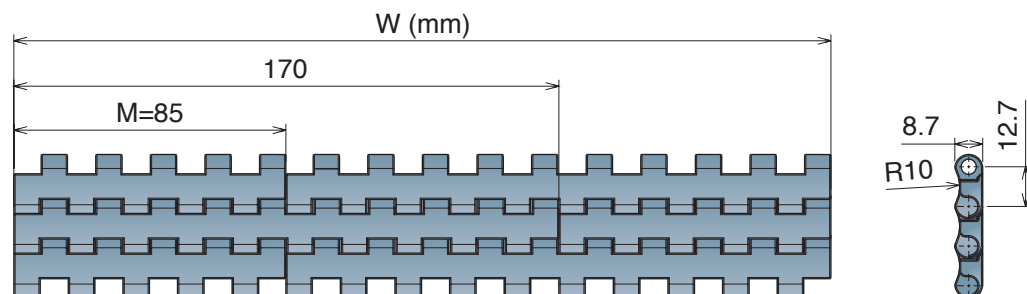

Version B - With 1 Positioner

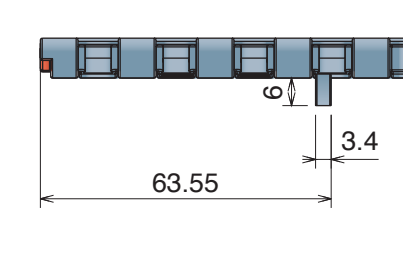

Version C - With 2 Positioners

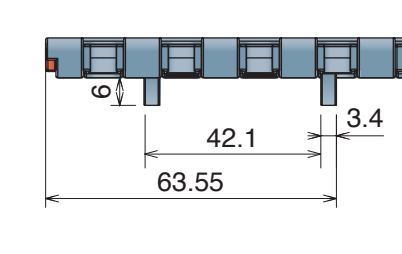

Version A - Standard

Series	Material	Width	Version
5201	*	0085	A
5201	*	0170	A
5201	*	0255	A
5201	*	0340	A
5201	*	0425	A
5201	*	0510	A
5201	*	0595	A
5201	*	0680	A
5201	*	0765	A
5201	*	0850	A
5201	*	0935	A
5201	*	1020	A
5201	*	1105	A
5201	*	1190	A
5201	*	1275	A
5201	*	1360	A
5201	*	1445	A
5201	*	1530	A

Version B - With 1 Positioner

Series	Material	Width	Version
5201	*	0085	B
5201	*	0170	B
5201	*	0255	B
5201	*	0340	B
5201	*	0425	B
5201	*	0510	B
5201	*	0595	B
5201	*	0680	B
5201	*	0765	B
5201	*	0850	B
5201	*	0935	B
5201	*	1020	B
5201	*	1105	B
5201	*	1190	B
5201	*	1275	B
5201	*	1360	B
5201	*	1445	B
5201	*	1530	B

Version C - With 2 Positioners

Series	Material	Width	Version
5201	*	0085	C
5201	*	0170	C
5201	*	0255	C
5201	*	0340	C
5201	*	0425	C
5201	*	0510	C
5201	*	0595	C
5201	*	0680	C
5201	*	0765	C
5201	*	0850	C
5201	*	0935	C
5201	*	1020	C
5201	*	1105	C
5201	*	1190	C
5201	*	1275	C
5201	*	1360	C
5201	*	1445	C
5201	*	1530	C

520 FTT

Tappeto Modulare 520 FTT, H=8,7 M=85
 Modular Belt Series 520 FTT, H=8,7 M=85 / Modulare Mattenkette 520 FTT, H=8,7 M=85

CODE STRUCTURE GUIDE			
(Example)			
5206	01	0170	CN
Series	*Material	Width	Version

Backflex radius min.: 10 mm



pg. 248-249

pg. 464->471

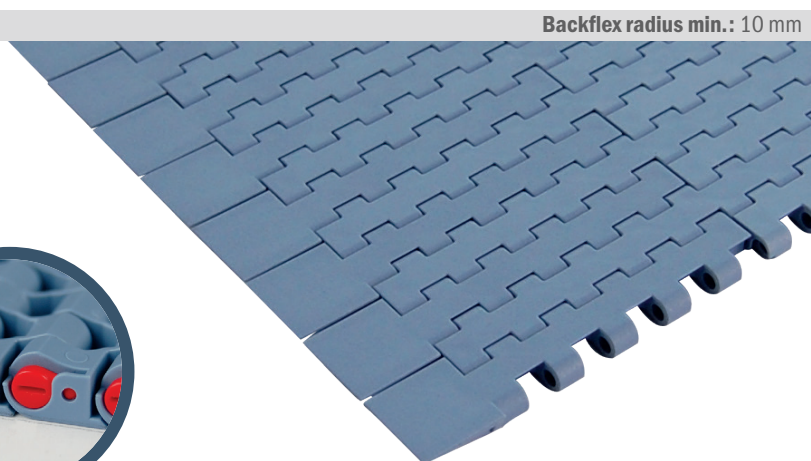
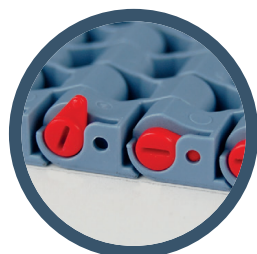

Metric Size

*Material

LFA - Code 01

Low friction Acetal

Max w. load: 21500 N/m
 Weight: 7,8 kg/m²
 Temp. range dry: -40÷80 °C
 Temp. range wet: -40÷65 °C
 Pin material: PBT white

PP - Code 02

Polypropylene

Max w. load: 13000 N/m
 Weight: 7,5 kg/m²
 Temp. range dry: 4÷80 °C
 Temp. range wet: 4÷65 °C
 Pin material: PP blu

MX - Code 03

Performance PBT

Max w. load: 17500 N/m
 Weight: 7,5 kg/m²
 Temp. range dry: -40÷120 °C
 Temp. range wet: 40÷60 °C
 Pin material: POM grey

DKM - Code 16

Aramid Reinforced Acetal

Max w. load: 21500 N/m
 Weight: 7,8 kg/m²
 Temp. range dry: -40÷80 °C
 Temp. range wet: -40÷65 °C
 Pin material: PBT white

MWX - Code 17

Polyamide Composite

Max w. load: 21500 N/m
 Weight: 7,8 kg/m²
 Temp. range dry: -40÷104 °C
 Temp. range wet: NR
 Pin material: PBT white

MPX - Code 25

Lubricated Acetal

Max w. load: 21500 N/m
 Weight: 7,8 kg/m²
 Temp. range dry: -40÷80 °C
 Temp. range wet: -40÷65 °C
 Pin material: PBT white

Version C

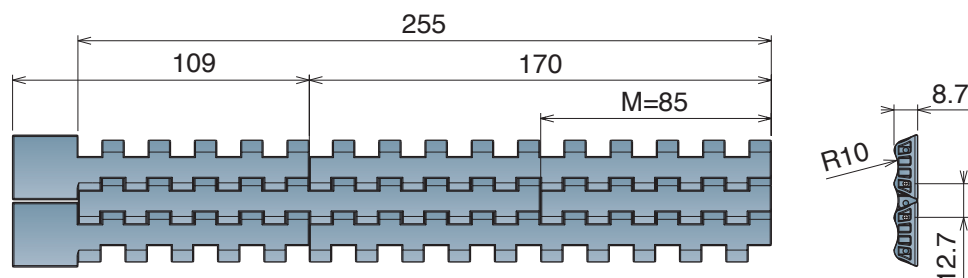

Version CN - Near

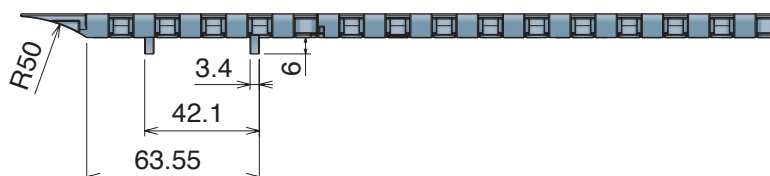

Version C0 - Opposite



Version C

Series	Material	Width	Version
5206	*	0085	C

Version CN - Near

Series	Material	Width	Version
5206	*	0170	CN
5206	*	0255	CN

Version C0 - Opposite

Series	Material	Width	Version
5206	*	0170	C0
5206	*	0255	C0

520 FG Open Surface 25% Tappeto Modulare 520 FG, H=8,7 M=85 Modular Belt Series 520 FG, H=8,7 M=85 / Modulare Mattenkette 520 FG, H=8,7 M=85

CODE STRUCTURE GUIDE			
(Example)			
5202	01	0765	A
Series	*Material	Width	Version

Backflex radius min.: 10 mm

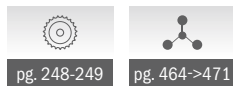

pg. 248-249

pg. 464->471

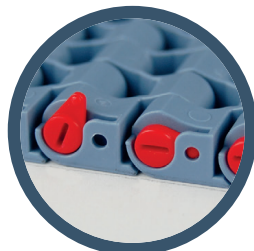
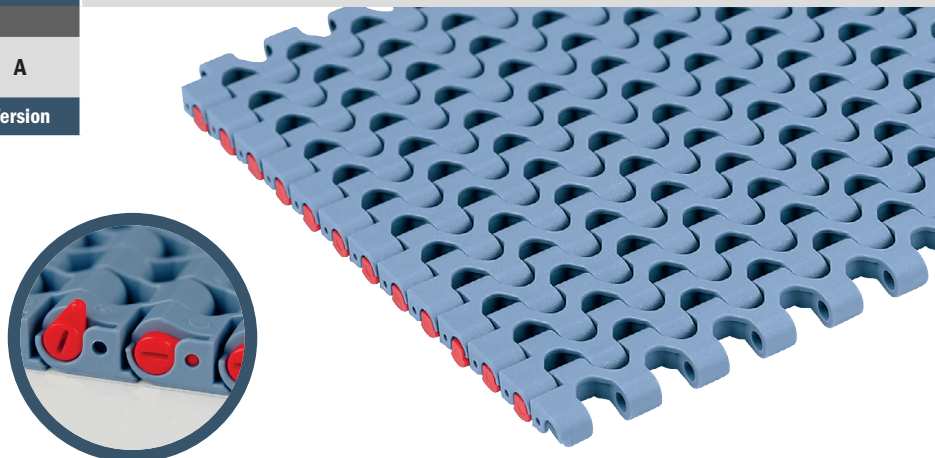

*Material

LFA - Code 01 Low friction Acetal

Max w. load: 21500 N/m
Weight: 7,5 kg/m²
Temp. range dry: -40+80 °C
Temp. range wet: -40+65 °C
Pin material: PBT white

PP - Code 02 Polypropylene

Max w. load: 13000 N/m
Weight: 7,5 kg/m²
Temp. range dry: 4+80 °C
Temp. range wet: 4+65 °C
Pin material: PP blu

MX - Code 03 Performance PBT

Max w. load: 17500 N/m
Weight: 7,2 kg/m²
Temp. range dry: -40+120 °C
Temp. range wet: -40+60 °C
Pin material: POM grey

DKM - Code 16 Aramid Reinforced Acetal

Max w. load: 21500 N/m
Weight: 7,5 kg/m²
Temp. range dry: -40+80 °C
Temp. range wet: -40+65 °C
Pin material: PBT white

MWX - Code 17 Polyamide Composite

Max w. load: 21500 N/m
Weight: 7,8 kg/m²
Temp. range dry: -40+104 °C
Temp. range wet: NR
Pin material: PBT white

MPX - Code 25 Lubricated Acetal

Max w. load: 21500 N/m
Weight: 7,5 kg/m²
Temp. range dry: -40+80 °C
Temp. range wet: -40+65 °C
Pin material: PBT white

Version A - Standard

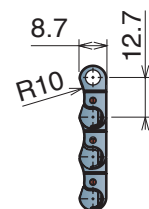
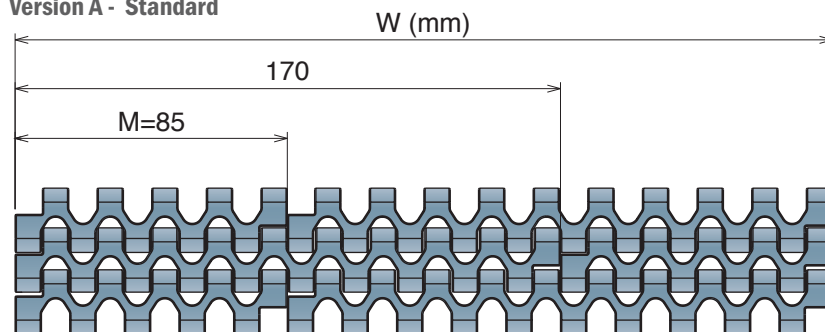

Version B - With 1 Positioner

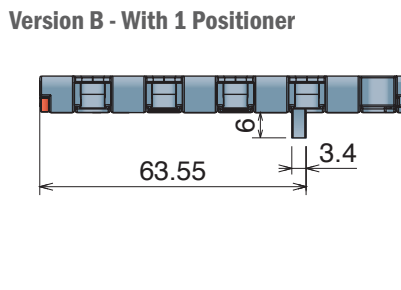

Version C - With 2 Positioners

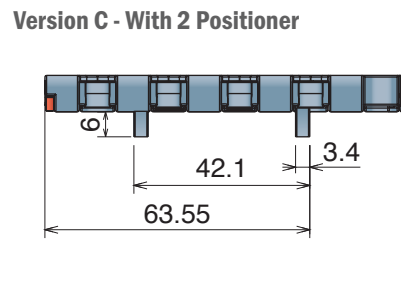

Version A - Standard

Series	Material	Width	Version
5202	*	0085	A
5202	*	0170	A
5202	*	0255	A
5202	*	0340	A
5202	*	0425	A
5202	*	0510	A
5202	*	0595	A
5202	*	0680	A
5202	*	0765	A
5202	*	0850	A
5202	*	0935	A
5202	*	1020	A
5202	*	1105	A
5202	*	1190	A
5202	*	1275	A
5202	*	1360	A
5202	*	1445	A
5202	*	1530	A

Version B - With 1 Positioner

Series	Material	Width	Version
5202	*	0085	B
5202	*	0170	B
5202	*	0255	B
5202	*	0340	B
5202	*	0425	B
5202	*	0510	B
5202	*	0595	B
5202	*	0680	B
5202	*	0765	B
5202	*	0850	B
5202	*	0935	B
5202	*	1020	B
5202	*	1105	B
5202	*	1190	B
5202	*	1275	B
5202	*	1360	B
5202	*	1445	B
5202	*	1530	B

Version C - With 2 Positioners

Series	Material	Width	Version
5202	*	0085	C
5202	*	0170	C
5202	*	0255	C
5202	*	0340	C
5202	*	0425	C
5202	*	0510	C
5202	*	0595	C
5202	*	0680	C
5202	*	0765	C
5202	*	0850	C
5202	*	0935	C
5202	*	1020	C
5202	*	1105	C
5202	*	1190	C
5202	*	1275	C
5202	*	1360	C
5202	*	1445	C
5202	*	1530	C

520 GT

Tappeto Modulare 520 GT, H=8,7 M=85

Modular Belt Series 520 GT, H=8,7 M=85 / Modulare Mattenkette 520 GT, H=8,7 M=85

CODE STRUCTURE GUIDE

(Example)

5203	02	0510	B
Series	*Material	Width	Version

Backflex radius min.: 20 mm

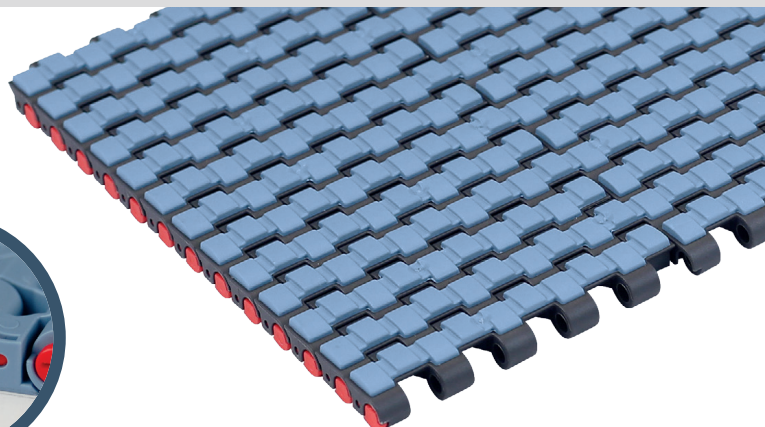

Metric Size



pg. 248-249



pg. 464->471

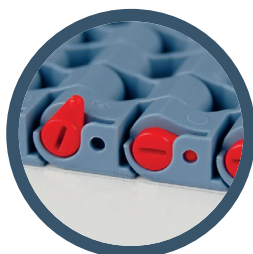

*Material

LFA - Code 01

Low friction Acetal

Max w. load: 21500 N/m
 Weight: 9,0 kg/m²
 Temp. range dry: -40÷80 °C
 Temp. range wet: -40÷65 °C
 Pin material: PBT white
 Hardness of
 Grip top Rubber: 75 Sha

PP - Code 02

Polypropylene

Max w. load: 13000 N/m
 Weight: 7,5 kg/m²
 Temp. range dry: 4÷80 °C
 Temp. range wet: 4÷65 °C
 Pin material: PP blu
 Hardness of
 Grip top Rubber: 75 Sha

MX - Code 03

Performance PBT

Max w. load: 17500 N/m
 Weight: 9,3 kg/m²
 Temp. range dry: -40÷120 °C
 Temp. range wet: -40÷60 °C
 Pin material: POM grey
 Hardness of
 Grip top Rubber: 75 Sha

Version A - Standard

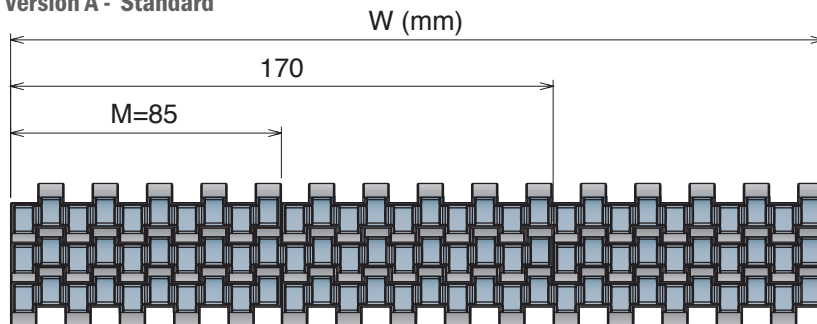

Version B - With 1 Positioner

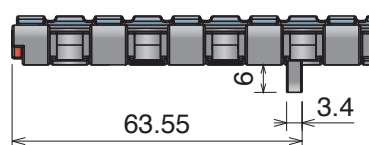

Version C - With 2 Positioner

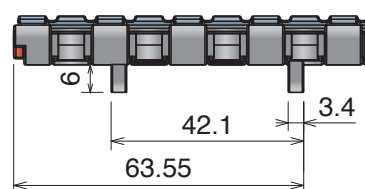

Version A - Standard

Series	Material	Width	Version
5203	*	0085	A
5203	*	0170	A
5203	*	0255	A
5203	*	0340	A
5203	*	0425	A
5203	*	0510	A
5203	*	0595	A
5203	*	0680	A
5203	*	0765	A
5203	*	0850	A
5203	*	0935	A
5203	*	1020	A
5203	*	1105	A
5203	*	1190	A
5203	*	1275	A
5203	*	1360	A
5203	*	1445	A
5203	*	1530	A

Version B - With 1 Positioner

Series	Material	Width	Version
5203	*	0085	B
5203	*	0170	B
5203	*	0255	B
5203	*	0340	B
5203	*	0425	B
5203	*	0510	B
5203	*	0595	B
5203	*	0680	B
5203	*	0765	B
5203	*	0850	B
5203	*	0935	B
5203	*	1020	B
5203	*	1105	B
5203	*	1190	B
5203	*	1275	B
5203	*	1360	B
5203	*	1445	B
5203	*	1530	B

Version C - With 2 Positioners

Series	Material	Width	Version
5203	*	0085	C
5203	*	0170	C
5203	*	0255	C
5203	*	0340	C
5203	*	0425	C
5203	*	0510	C
5203	*	0595	C
5203	*	0680	C
5203	*	0765	C
5203	*	0850	C
5203	*	0935	C
5203	*	1020	C
5203	*	1105	C
5203	*	1190	C
5203	*	1275	C
5203	*	1360	C
5203	*	1445	C
5203	*	1530	C

Available also with
50 Sha Rubber

520 LBP

Tappeto Modulare 520 LBP, H=8,7 M=85

Modular Belt Series 520 LBP, H=8,7 M=85 / Modulare Mattenkette 520 LBP, H=8,7 M=85

CODE STRUCTURE GUIDE			
(Example)			
5204	01	1530	C
Series	*Material	Width	Version

Backflex radius min.: 65 mm

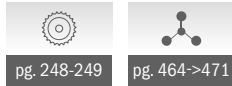

pg. 248-249

pg. 464-471

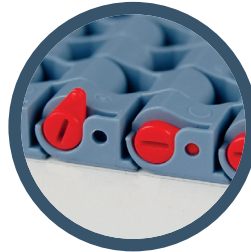
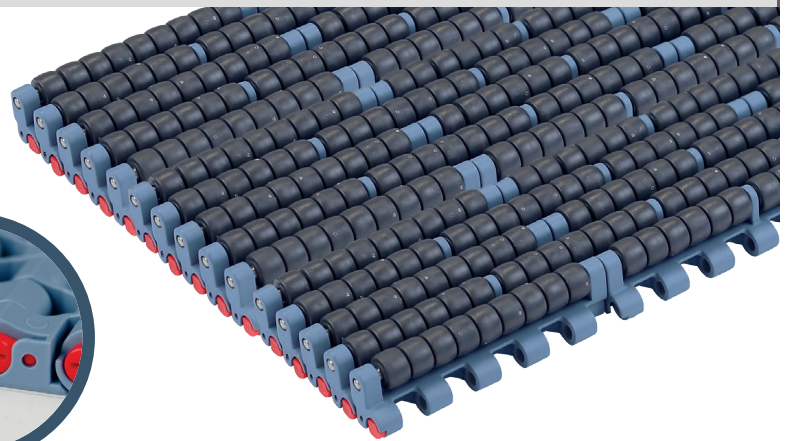

Version A - Standard

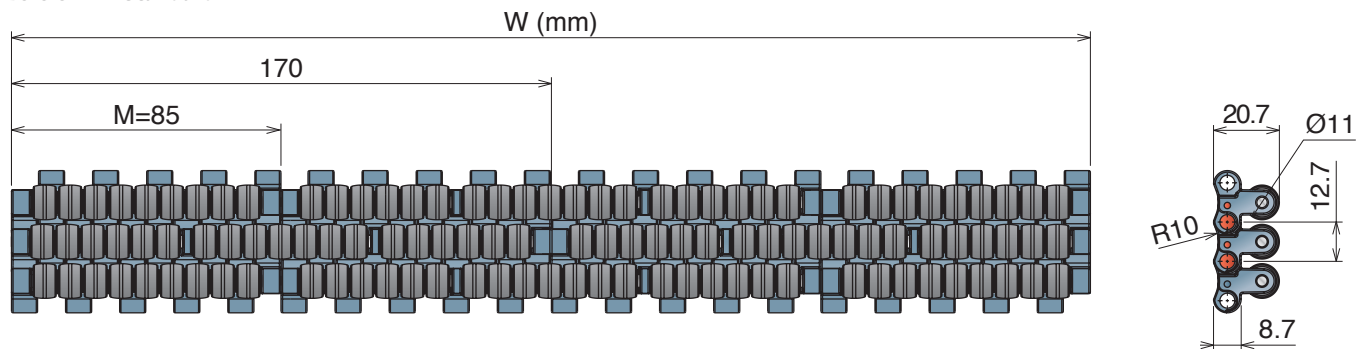

*Material

LFA - Code 01

Low friction Acetal

Max w. load: 21500 N/m
 Weight: 24,0 kg/m²
 Temp. range dry: -40+80 °C
 Temp. range wet: 1+65 °C
 Pin material: PBT white

Version B - With 1 Positioner

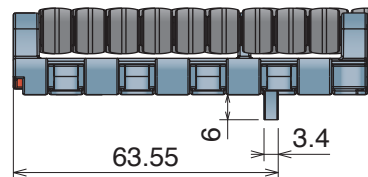

Version C - With 2 Positioners

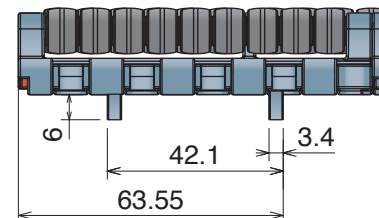

Version A - Standard

Series	Material	Width	Version
5204	*	0085	A
5204	*	0170	A
5204	*	0255	A
5204	*	0340	A
5204	*	0425	A
5204	*	0510	A
5204	*	0595	A
5204	*	0680	A
5204	*	0765	A
5204	*	0850	A
5204	*	0935	A
5204	*	1020	A
5204	*	1105	A
5204	*	1190	A
5204	*	1275	A
5204	*	1360	A
5204	*	1445	A
5204	*	1530	A

Version B - With 1 Positioner

Series	Material	Width	Version
5204	*	0085	B
5204	*	0170	B
5204	*	0255	B
5204	*	0340	B
5204	*	0425	B
5204	*	0510	B
5204	*	0595	B
5204	*	0680	B
5204	*	0765	B
5204	*	0850	B
5204	*	0935	B
5204	*	1020	B
5204	*	1105	B
5204	*	1190	B
5204	*	1275	B
5204	*	1360	B
5204	*	1445	B
5204	*	1530	B

Version C - With 2 Positioners

Series	Material	Width	Version
5204	*	0085	C
5204	*	0170	C
5204	*	0255	C
5204	*	0340	C
5204	*	0425	C
5204	*	0510	C
5204	*	0595	C
5204	*	0680	C
5204	*	0765	C
5204	*	0850	C
5204	*	0935	C
5204	*	1020	C
5204	*	1105	C
5204	*	1190	C
5204	*	1275	C
5204	*	1360	C
5204	*	1445	C
5204	*	1530	C

520 M

Tappeto Modulare 520 M, H=8,7 M=85
 Modular Belt Series 520 M, H=8,7 M=85 / Modulare Mattenkette 520 M, H=8,7 M=85

New

Part	Article-Nr.	Ref.	A	Weight	*Material	Backflex radius min.: 15 mm
1193	1193019330	520 M K330	83,8	1,11	LFA	
1193	1193039330	520 M K330	83,8	1,11	MX	
1193	1193139330	520 M K330	83,8	1,11	MPX	

10 feet 3.048 m	pg. 248-249	pg. 150->156	pg. 464->471
240 links			

Magnetic System

*Material

LFA - Code 01

Low friction Acetal

Max w. load: 2500 N/m
 Weight: 7,5 kg/m²
 Temp. range dry: -40÷80 °C
 Temp. range wet: -40÷65 °C
 Pin material: Ferritic
 Stainless Steel

MX - Code 03

Performance PBT

Max w. load: 2000 N/m
 Weight: 7,2 kg/m²
 Temp. range dry: -40÷120 °C
 Temp. range wet: -40÷60 °C
 Pin material: Ferritic
 Stainless Steel

MPX - Code 25

Lubricated Acetal

Max w. load: 2500 N/m
 Weight: 7,5 kg/m²
 Temp. range dry: -40÷80 °C
 Temp. range wet: -40÷65 °C
 Pin material: Ferritic
 Stainless Steel

Version A - Standard

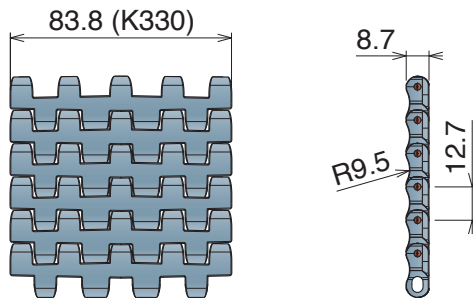

Coventional layout

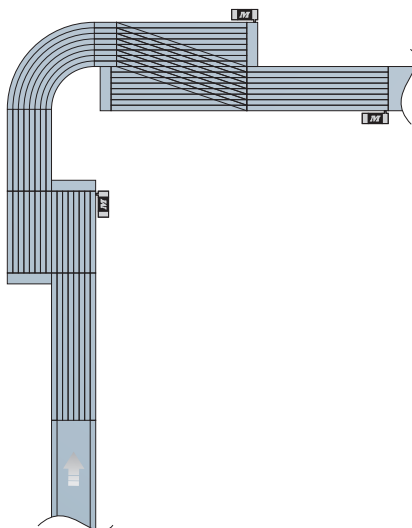

Layout with 520 M K330

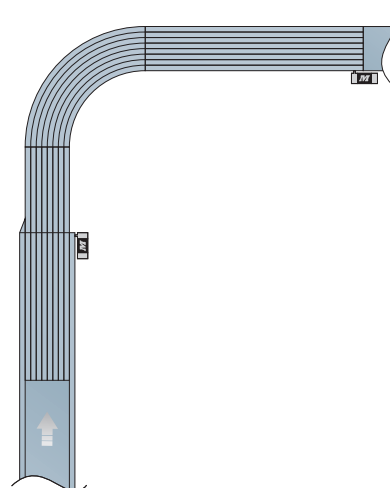

Transfer plate system recommended

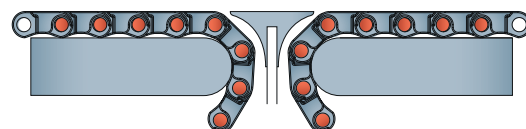

Advantages:

No side transfer
 Space saving

Cost savings:

Less belt required
 Less conveyor length required
 Less guides required
 Less drives required

Metric Size

521 FT

Tappeto Modulare 521 FT, H=8,7 M=7,5"
Modular Belt Series 521 FT, H=8,7 M=7,5" / Modulare Mattenkette 521 FT, H=8,7 M=7,5"

CODE STRUCTURE GUIDE			
(Example)			
5311	01	9750	C
Series	*Material	Width	Version

Backflex radius min.: 10 mm



pg. 247

pg. 464->471

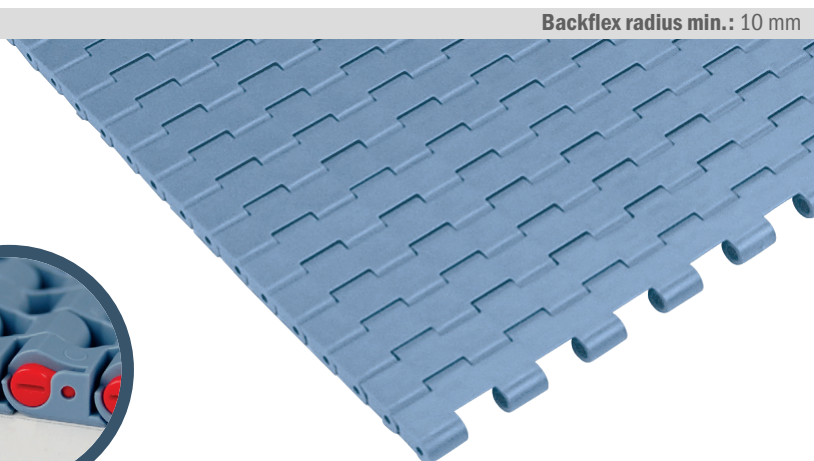
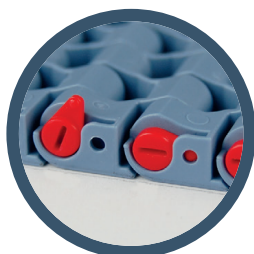

*Material

LFA - Code 01

Low friction Acetal

Max w. load: 21500 N/m
Weight: 8,0 kg/m²
Temp. range dry: -40+80 °C
Temp. range wet: -40+65 °C
Pin material: PBT white

MX - Code 03

Performance PBT

Max w. load: 17500 N/m
Weight: 7,8 kg/m²
Temp. range dry: -40+120 °C
Temp. range wet: -40+60 °C
Pin material: POM grey

DKM - Code 16

Aramide Reinforced Acetal

Max w. load: 21500 N/m
Weight: 8,0 kg/m²
Temp. range dry: -40+80 °C
Temp. range wet: -40+65 °C
Pin material: PBT white

MWX - Code 17

Polyamide Composite

Max w. load: 21500 N/m
Weight: 8,3 kg/m²
Temp. range dry: -40+104 °C
Temp. range wet: NR
Pin material: PBT white

MPX - Code 25

Lubricated Acetal

Max w. load: 21500 N/m
Weight: 8,0 kg/m²
Temp. range dry: -40+80 °C
Temp. range wet: -40+65 °C
Pin material: PBT white

Version A - Standard

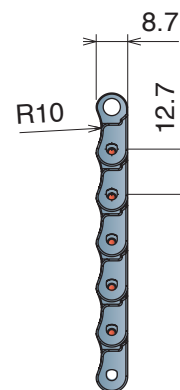
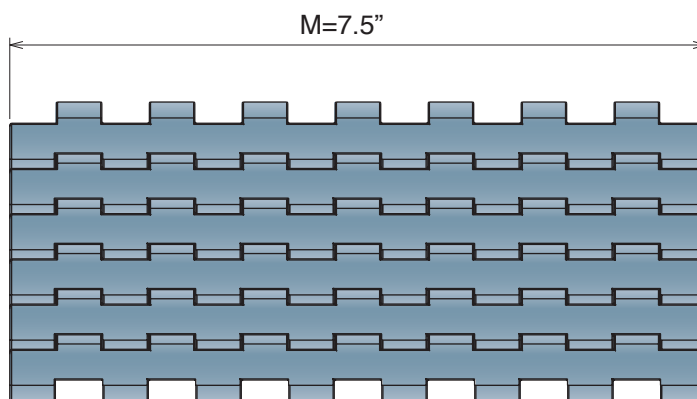

Version B - With 1 Positioner

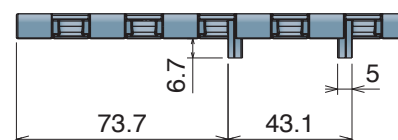

Version A - Standard

Series	Material	Width	Version
5311	*	9750	A

Version C - With 2 Positioners

Series	Material	Width	Version
5311	*	9750	C

228

Piatto di trasferimento
 Transfer Plate / Überschubplatte

Used with belt series 520 - 521 - 525 - 530

Transfer plate

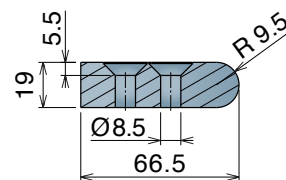
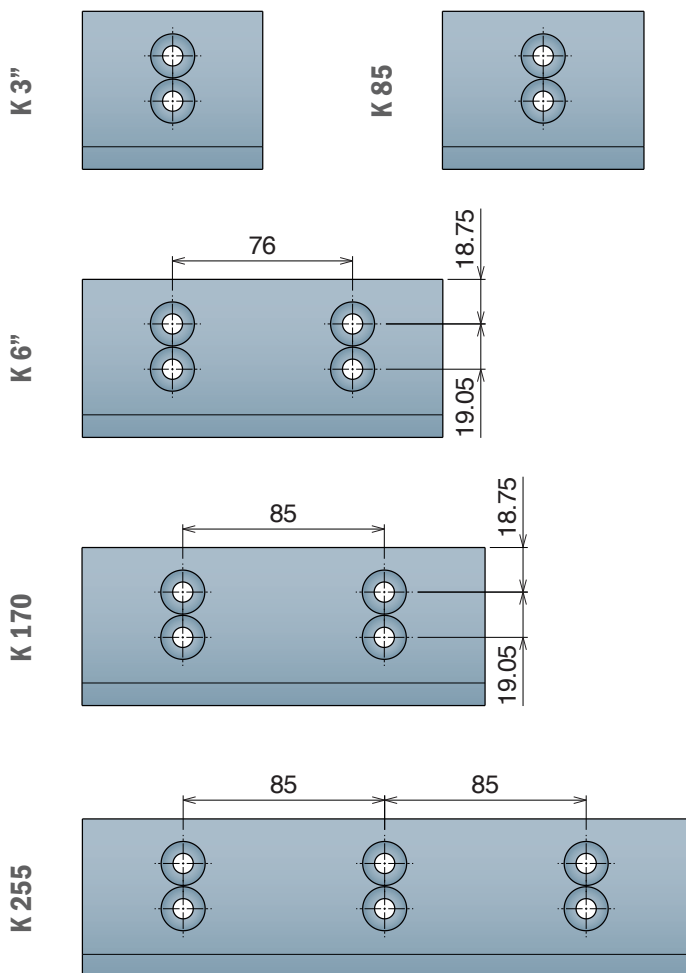

Part	Article-Nr.	K
228	22801	85
228	22802	170
228	22803	255
228	22808	76
228	22809	152,4

Available in different widths on request.

Transfer plate with rollers

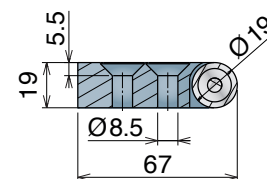
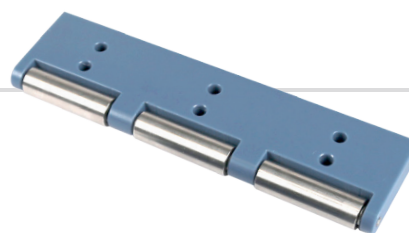
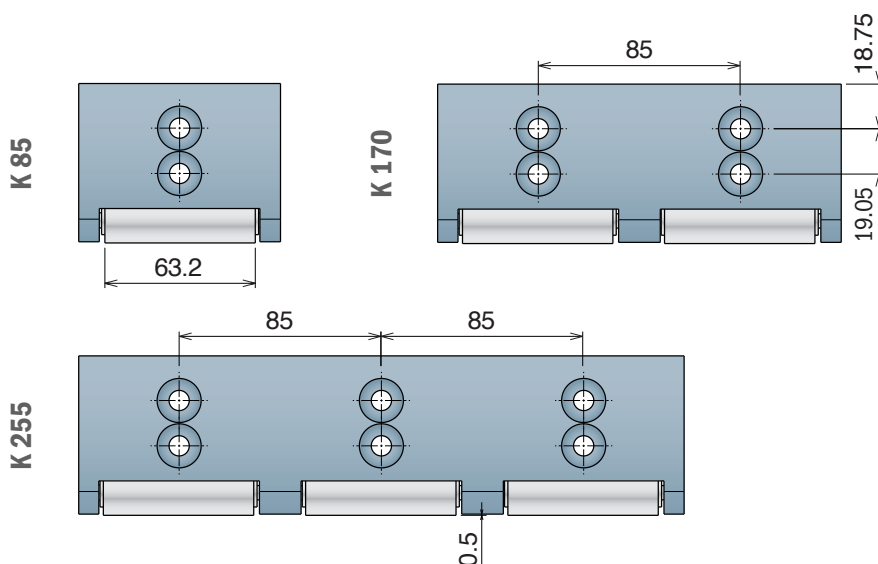

Part	Article-Nr.	K
228	22814	85
228	22815	170
228	22816	255

Available in different widths on request.

228 Piatto di trasferimento Transfer Plate / Überschubplatte

Used with belt series 520 - 521 - 525 - 530

Transfer plate with bearings

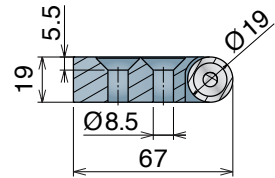
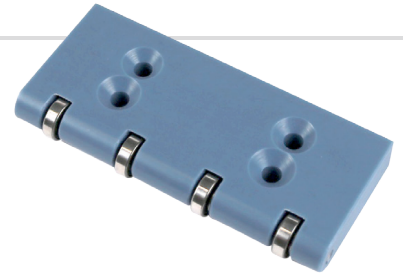
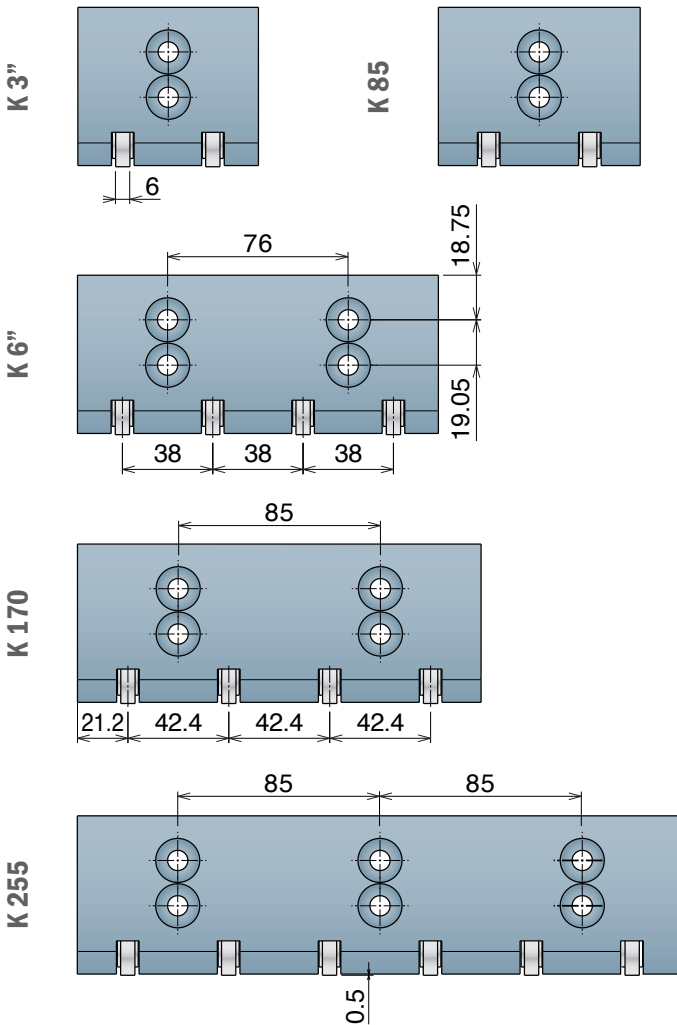

Part	Article-Nr.	K
228	22861	75.8
228	22811	85
228	22862	151.8
228	22812	170
228	22813	255

Available in different widths on request.

INSTALLATION TIPS

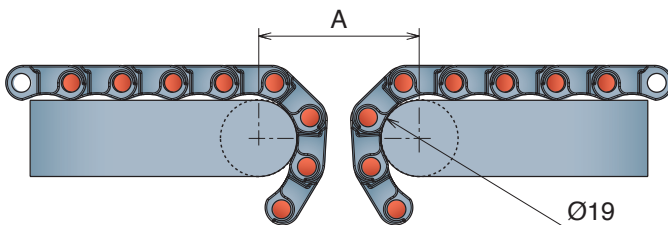

Belt type 1	Belt type 2	A
FT/ FG	FT/ FG	40
FT/ FG	GT	42
FT/ FG	LBP	53
GT	GT	44
GT	LBP	55
LBP	LBP	65

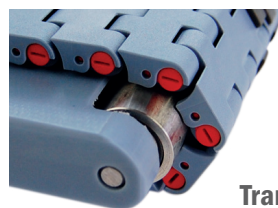

Transfer plate with roller

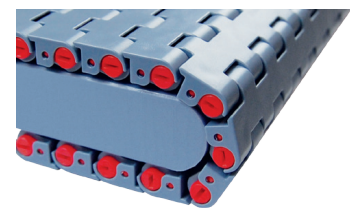

Transfer plate

228

Piatto di trasferimento
 Transfer Plate / Überschubplatte

Used with belt series 520 - 525

With positioner and Bearings

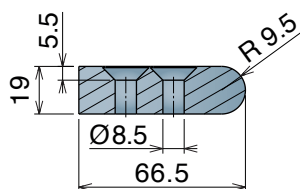
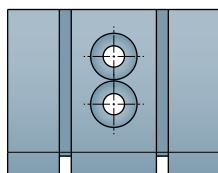
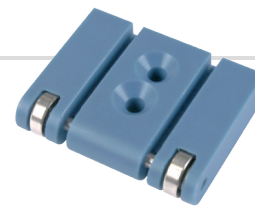

Part	Article-Nr.	K
228	22807	85

Available in different widths on request.

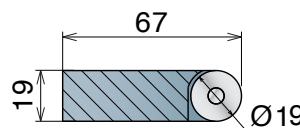
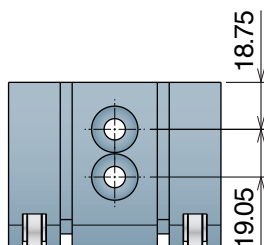

Part	Article-Nr.	K
228	22817	85

Available in different widths on request.

228

Piatto di trasferimento
 Transfer Plate / Überschubplatte

Used with belt series 510

For micropitch

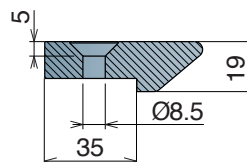
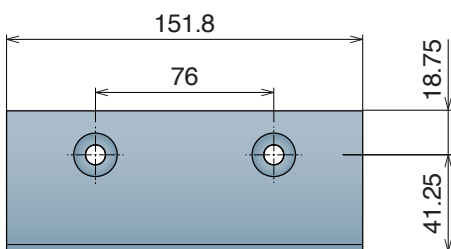
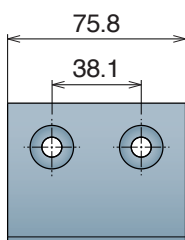
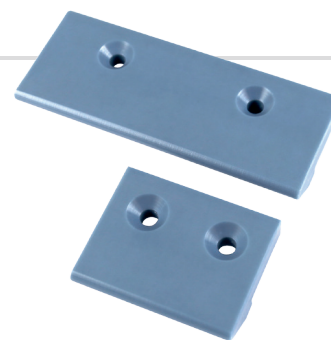

Part	Article-Nr.	K
228	22818	75.8
228	22819	151.8

Available in different widths on request.

590

Pitch 19,05 mm
H= 8,7 mm



590 FT
590 FT *One track Belt*
590 FTT

590 FT

Tappeto Modulare 590 FT, H=8,7 M=3"
 Modular Belt Series 590 FT, H=8,7 M=3" / Modulare Mattenkette 590 FT, H=8,7 M=3"

CODE STRUCTURE GUIDE			
(Example)			
5301	01	0009	C
Series	*Material	Width	Version

Backflex radius min.: 25 mm

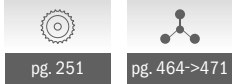

pg. 251

pg. 464->471

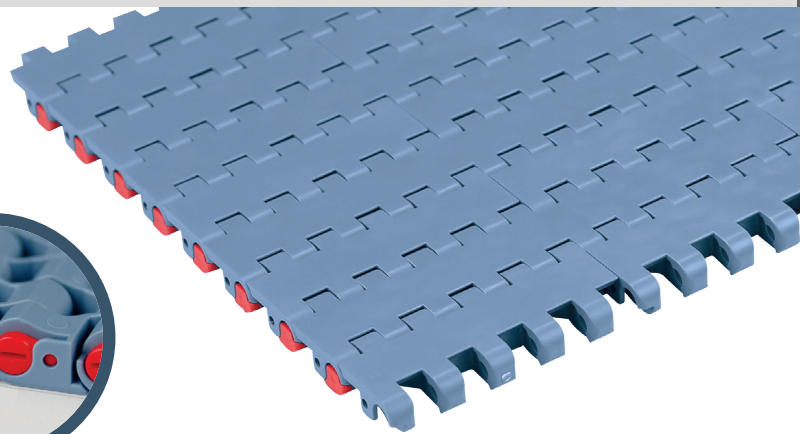
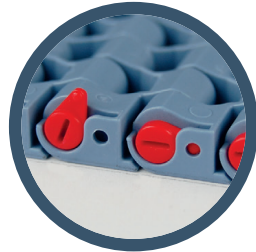

Imperial Size

***Material**

LFA - Code 01

Low friction Acetal

Max w. load: 30000 N/m
 Weight: 7,2 kg/m²
 Temp. range dry: -40÷80 °C
 Temp. range wet: -40÷65 °C
 Pin material: PBT white

MX - Code 03

Performance PBT

Max w. load: 24000 N/m
 Weight: 7,0 kg/m²
 Temp. range dry: -40÷120 °C
 Temp. range wet: -40÷60 °C
 Pin material: POM grey

DKM - Code 16

Aramide Reinforced Acetal

Max w. load: 30000 N/m
 Weight: 7,2 kg/m²
 Temp. range dry: -40÷80 °C
 Temp. range wet: -40÷65 °C
 Pin material: PBT white

MWX - Code 17

Polyamide Composite

Max w. load: 30000 N/m
 Weight: 7,5 kg/m²
 Temp. range dry: -40÷104 °C
 Temp. range wet: NR
 Pin material: PBT white

MPX - Code 25

Lubricated Acetal

Max w. load: 30000 N/m
 Weight: 7,2 kg/m²
 Temp. range dry: -40÷80 °C
 Temp. range wet: -40÷65 °C
 Pin material: PBT white

Version A - Standard

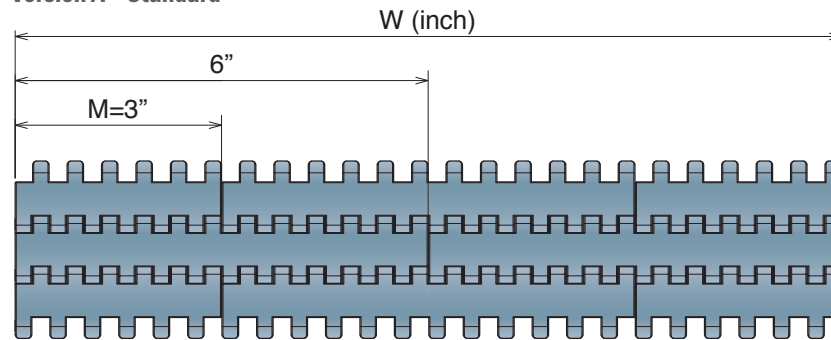

Version C - With 2 Positioner

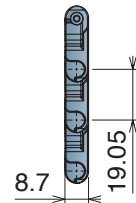
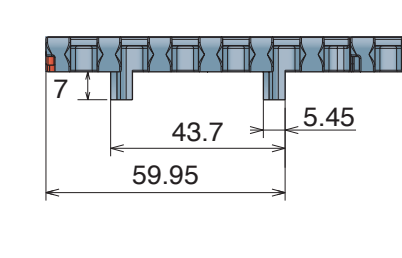

Version A - Standard

Series	Material	Width	Version
5301	*	0003	A
5301	*	0006	A
5301	*	0009	A
5301	*	0012	A
5301	*	0015	A
5301	*	0018	A
5301	*	0021	A
5301	*	0024	A
5301	*	0027	A
5301	*	0030	A
5301	*	0033	A
5301	*	0036	A
5301	*	0039	A
5301	*	0042	A
5301	*	0045	A
5301	*	0048	A
5301	*	0051	A
5301	*	0054	A

Version C - With 2 Positioners

Series	Material	Width	Version
5301	*	0003	C
5301	*	0006	C
5301	*	0009	C
5301	*	0012	C
5301	*	0015	C
5301	*	0018	C
5301	*	0021	C
5301	*	0024	C
5301	*	0027	C
5301	*	0030	C
5301	*	0033	C
5301	*	0036	C
5301	*	0039	C
5301	*	0042	C
5301	*	0045	C
5301	*	0048	C
5301	*	0051	C
5301	*	0054	C

590 FT One track Belt

Tappeti modulari / Modular belts / Mattenketten

Imperial Size

590 FT One track Belt

Tappeto Modulare 590 FT, H=8,7
Modular Belt Series 590 FT, H=8,7 / Modulare Mattenkette 590 FT, H=8,7

CODE STRUCTURE GUIDE			
(Example)			
5301	03	9325	C
Series	*Material	Width	Version

Backflex radius min.: 25 mm

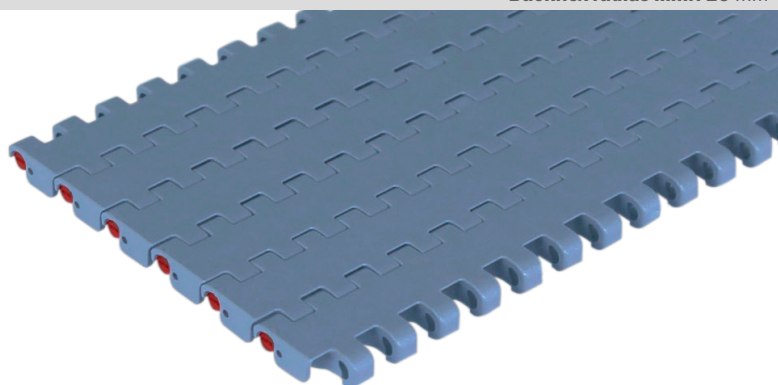

Version A - Standard

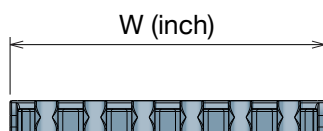

Version C - With 2 Positioner

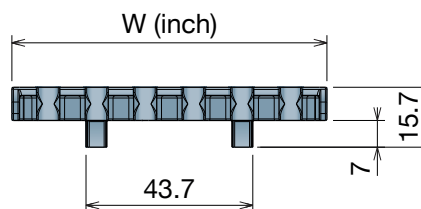

*Material

LFA - Code 01

Low friction Acetal

Max w. load: 30000 N/m
Weight: 7,2 kg/m²
Temp. range dry: -40+80 °C
Temp. range wet: -40+65 °C
Pin material: PBT white

MX - Code 03

Performance PBT

Max w. load: 24000 N/m
Weight: 7,0 kg/m²
Temp. range dry: -40+120 °C
Temp. range wet: -40+60 °C
Pin material: POM grey

DKM - Code 16

Aramide Reinforced Acetal

Max w. load: 30000 N/m
Weight: 7,2 kg/m²
Temp. range dry: -40+80 °C
Temp. range wet: -40+65 °C
Pin material: PBT white

MWX - Code 17

Polyamide Composite

Max w. load: 30000 N/m
Weight: 7,5 kg/m²
Temp. range dry: -40+104 °C
Temp. range wet: NR
Pin material: PBT white

MPX - Code 25

Lubricated Acetal

Max w. load: 30000 N/m
Weight: 7,2 kg/m²
Temp. range dry: -40+80 °C
Temp. range wet: -40+65 °C
Pin material: PBT white

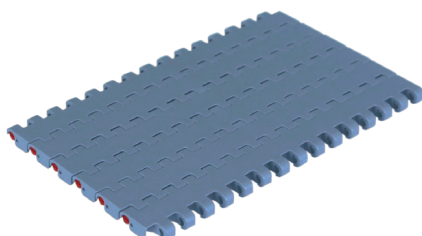
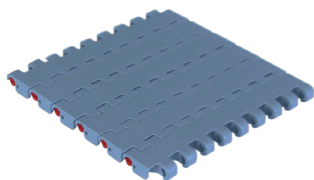
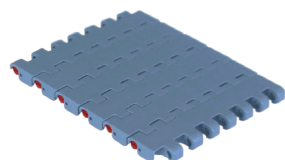

K325 - One track belt

Series	Material	Width	Version
5301	*	9325	A
5301	*	9325	C

K450 - One track belt

Series	Material	Width	Version
5301	*	9450	A
5301	*	9450	C

K750 - One track belt

Series	Material	Width	Version
5301	*	9750	A
5301	*	9750	C

Tappeti modulari / Modular belts / Mattenketten

590 FTT

Tappeto Modulare 590 FTT, H=8,7
 Modular Belt Series 590 FTT, H=8,7 / Modulare Mattenkette 590 FTT, H=8,7

CODE STRUCTURE GUIDE			
(Example)			
5306	01	9450	C-R
Series	*Material	Width	Version

Backflex radius min.: 25 mm



pg. 251



pg. 464->471

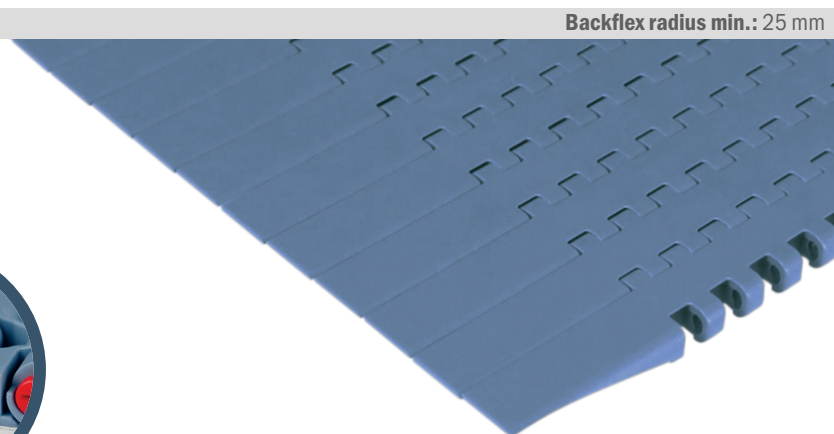
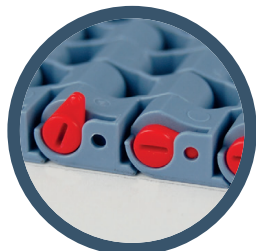

Imperial Size

*Material

LFA - Code 01

Low friction Acetal

Max w. load: 30000 N/m
 Weight: 7,2 kg/m²
 Temp. range dry: -40÷80 °C
 Temp. range wet: -40÷65 °C
 Pin material: PBT white

MX - Code 03

Performance PBT

Max w. load: 24000 N/m
 Weight: 7,0 kg/m²
 Temp. range dry: -40÷120 °C
 Temp. range wet: -40÷60 °C
 Pin material: POM grey

DKM - Code 16

Aramide Reinforced Acetal

Max w. load: 30000 N/m
 Weight: 7,2 kg/m²
 Temp. range dry: -40÷80 °C
 Temp. range wet: -40÷65 °C
 Pin material: PBT white

MWX - Code 17

Polyamide Composite

Max w. load: 30000 N/m
 Weight: 7,5 kg/m²
 Temp. range dry: -40÷104 °C
 Temp. range wet: NR
 Pin material: PBT white

MPX - Code 25

Lubricated Acetal

Max w. load: 30000 N/m
 Weight: 7,2 kg/m²
 Temp. range dry: -40÷80 °C
 Temp. range wet: -40÷65 °C
 Pin material: PBT white

Version 590 FTT DX

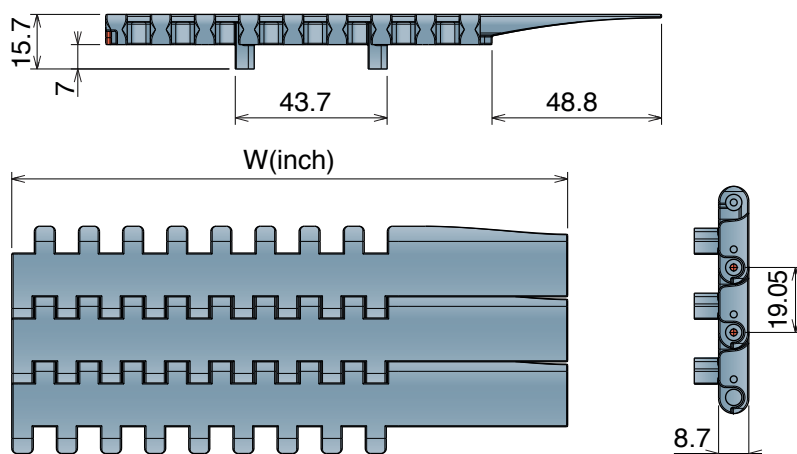

Version 590 FTT SX

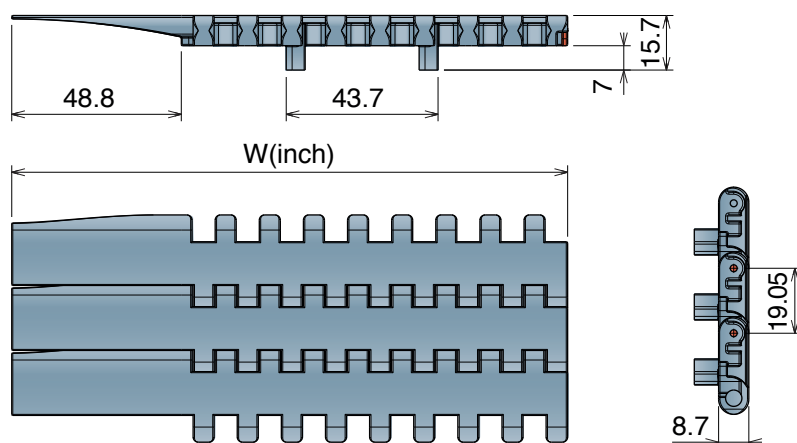

Version 590 FTT DX

Series	Material	Width	Version
5306	*	9450	C-R
5306	*	9750	C-R

Version 590 FTT SX

Series	Material	Width	Version
5306	*	9450	C-L
5306	*	9750	C-L

525

Pitch 15 mm
H= 8,7 mm

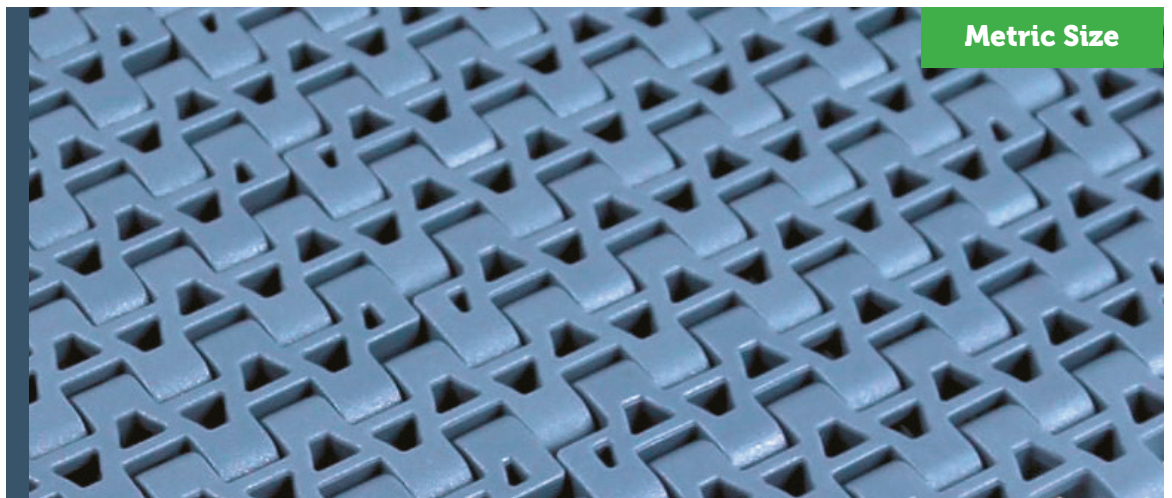

Metric Size

525 HD FT
525 FTT
525 HD FG
525 HD GT
525 HD GT *Side Indent*

525 HD FT

Tappeto Modulare 525 HD, H=8,7 M=85
 Modular Belt Series 525 HD, H=8,7 M=85 / Modulare Mattenkette 525 HD, H=8,7 M=85

CODE STRUCTURE GUIDE			
(Example)			
5261	03	0340	C
Series	*Material	Width	Version

Backflex radius min.: 25 mm

New

Metric Size

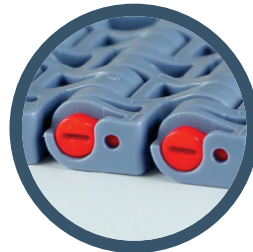
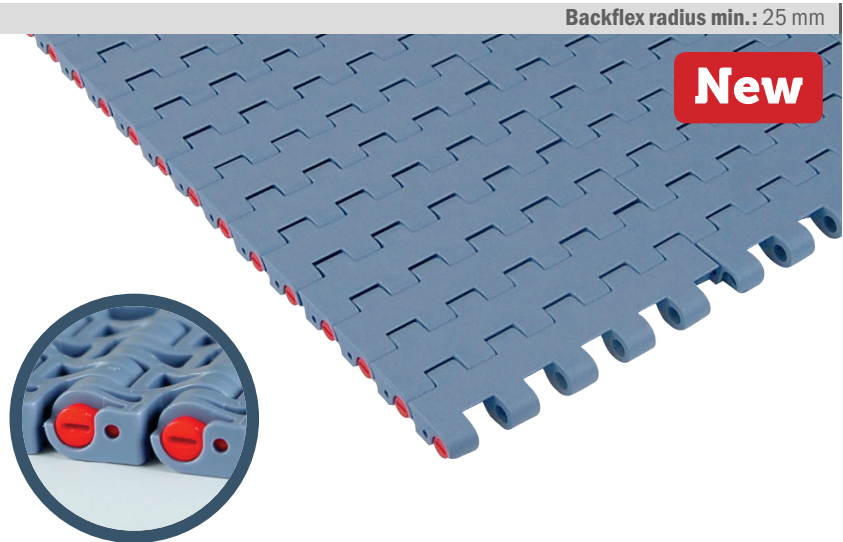

*Material

LFA - Code 01

Low friction Acetal

Max w. load: 25500 N/m
 Weight: 9,0 kg/m²
 Temp. range dry: -40÷80 °C
 Temp. range wet: -40÷65 °C
 Pin material: PBT white

MX - Code 03

Performance PBT

Max w. load: 20500 N/m
 Weight: 8,7 kg/m²
 Temp. range dry: -40÷120 °C
 Temp. range wet: -40÷60 °C
 Pin material: POM grey

DKM - Code 16

Aramide Reinforced Acetal

Max w. load: 25500 N/m
 Weight: 9,0 kg/m²
 Temp. range dry: -40÷80 °C
 Temp. range wet: -40÷65 °C
 Pin material: PBT white

MWX - Code 17

Polyamide Composite

Max w. load: 25500 N/m
 Weight: 9,3 kg/m²
 Temp. range dry: -40÷104 °C
 Temp. range wet: NR
 Pin material: PBT white

MPX - Code 25

Lubricated Acetal

Max w. load: 25500 N/m
 Weight: 9,0 kg/m²
 Temp. range dry: -40÷80 °C
 Temp. range wet: -40÷65 °C
 Pin material: PBT white

Version A - Standard

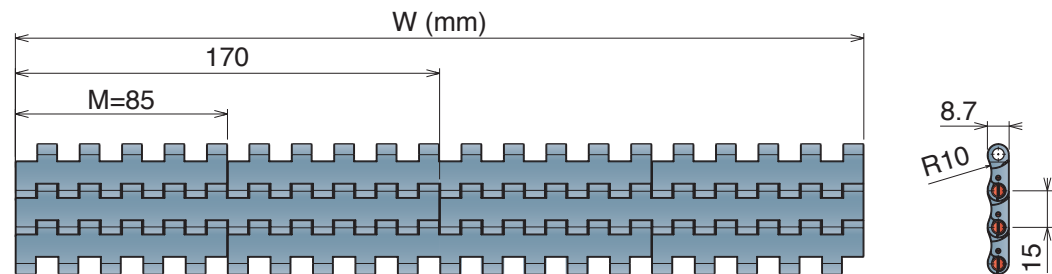

Version B - With 1 Positioner

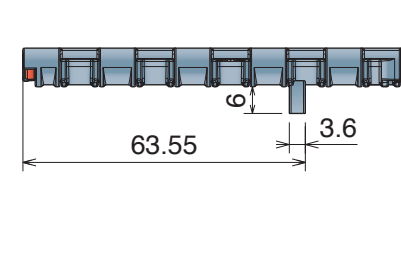

Version C - With 2 Positioner

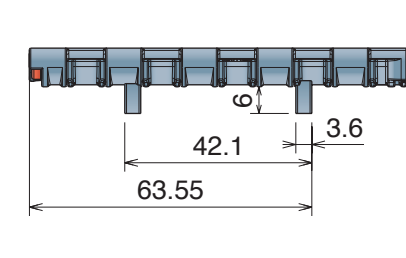

Version A - Standard

Series	Material	Width	Version
5261	*	0085	A
5261	*	0170	A
5261	*	0255	A
5261	*	0340	A
5261	*	0425	A
5261	*	0510	A
5261	*	0595	A
5261	*	0680	A
5261	*	0765	A
5261	*	0850	A
5261	*	0935	A
5261	*	1020	A
5261	*	1105	A
5261	*	1190	A
5261	*	1275	A
5261	*	1360	A
5261	*	1445	A
5261	*	1530	A

Version B - With 1 Positioner

Series	Material	Width	Version
5261	*	0085	B
5261	*	0170	B
5261	*	0255	B
5261	*	0340	B
5261	*	0425	B
5261	*	0510	B
5261	*	0595	B
5261	*	0680	B
5261	*	0765	B
5261	*	0850	B
5261	*	0935	B
5261	*	1020	B
5261	*	1105	B
5261	*	1190	B
5261	*	1275	B
5261	*	1360	B
5261	*	1445	B
5261	*	1530	B

Version C - With 2 Positioners

Series	Material	Width	Version
5261	*	0085	C
5261	*	0170	C
5261	*	0255	C
5261	*	0340	C
5261	*	0425	C
5261	*	0510	C
5261	*	0595	C
5261	*	0680	C
5261	*	0765	C
5261	*	0850	C
5261	*	0935	C
5261	*	1020	C
5261	*	1105	C
5261	*	1190	C
5261	*	1275	C
5261	*	1360	C
5261	*	1445	C
5261	*	1530	C

525 FTT

Tappeto Modulare 525 FTT, H=8,7 M=85
 Modular Belt Series 525 FTT, H=8,7 M=85 / Modulare Mattenkette 525 FTT, H=8,7 M=85

CODE STRUCTURE GUIDE			
(Example)			
5256	03	0085	C
Series	*Material	Width	Version

Backflex radius min.: 25 mm

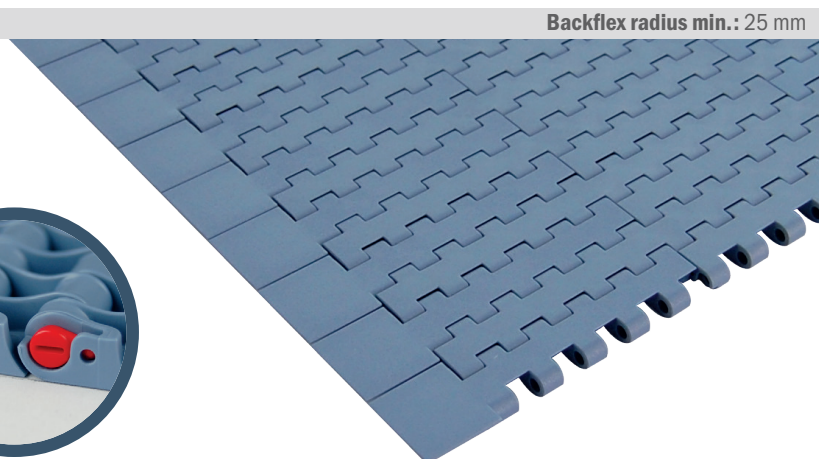
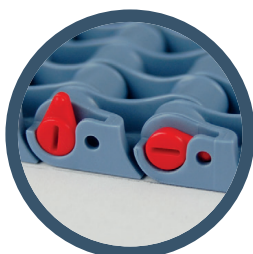

*Material

LFA - Code 01 Low friction Acetal

Max w. load: 21500 N/m
 Weight: 7,8 kg/m²
 Temp. range dry: -40÷80 °C
 Temp. range wet: -40÷65 °C
 Pin material: PBT white

MX - Code 03 Performance PBT

Max w. load: 17500 N/m
 Weight: 7,5 kg/m²
 Temp. range dry: -40÷120 °C
 Temp. range wet: -40÷60 °C
 Pin material: POM grey

DKM - Code 16 Aramide Reinforced Acetal

Max w. load: 21500 N/m
 Weight: 7,8 kg/m²
 Temp. range dry: -40÷80 °C
 Temp. range wet: -40÷65 °C
 Pin material: PBT white

MWX - Code 17 Polyamide Composite

Max w. load: 21500 N/m
 Weight: 8,1 kg/m²
 Temp. range dry: -40÷104 °C
 Temp. range wet: NR
 Pin material: PBT white

MPX - Code 25 Lubricated Acetal

Max w. load: 21500 N/m
 Weight: 7,8 kg/m²
 Temp. range dry: -40÷80 °C
 Temp. range wet: -40÷65 °C
 Pin material: PBT white

Version C

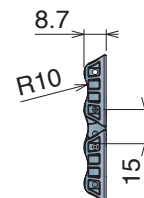
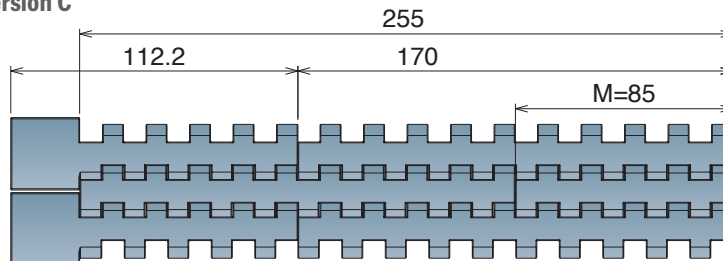

Version CN - Near



Version CO - Opposite



Version C

Series	Material	Width	Version
5256	*	0085	C

Version CN - Near

Series	Material	Width	Version
5256	*	0170	CN
5256	*	0255	CN

Version CO - Opposite

Series	Material	Width	Version
5256	*	0170	CO
5256	*	0255	CO



FT + Rib

SPECIAL APPLICATION IN PALLETIZER

ADD ON CODE:

- XR3 (RIB every 3 links) - XR5 (RIB every 5 links)

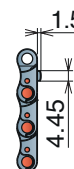
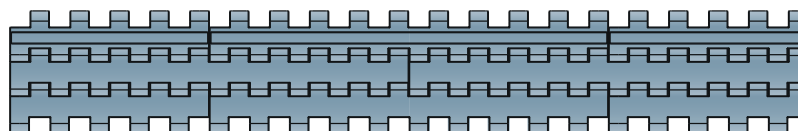

525 HD FG Tappeto Modulare 525 HD Flush grid, H=8,7 M=85

Modular Belt Series 525 HD Flush grid, H=8,7 M=85 / Modulare Mattenkette 525 HD Flush grid, H=8,7 M=85

CODE STRUCTURE GUIDE			
(Example)			
5262	03	0340	C
Series	*Material	Width	Version

Backflex radius min.: 25 mm

New

Metric Size



pg. 250

pg. 464->471

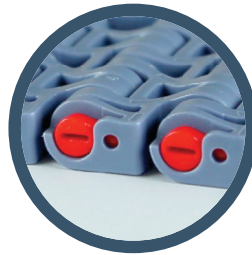

*Material

LFA - Code 01

Low friction Acetal

Max w. load: 25500 N/m
 Weight: 8,1 kg/m²
 Temp. range dry: -40÷80 °C
 Temp. range wet: -40÷65 °C
 Pin material: PBT white

MX - Code 03

Performance PBT

Max w. load: 20500 N/m
 Weight: 7,8 kg/m²
 Temp. range dry: -40÷120 °C
 Temp. range wet: -40÷60 °C
 Pin material: POM grey

DKM - Code 16

Aramide Reinforced Acetal

Max w. load: 25500 N/m
 Weight: 8,1 kg/m²
 Temp. range dry: -40÷80 °C
 Temp. range wet: -40÷65 °C
 Pin material: PBT white

MWX - Code 17

Polyamide Composite

Max w. load: 25500 N/m
 Weight: 8,4 kg/m²
 Temp. range dry: -40÷104 °C
 Temp. range wet: -40÷80 °C
 Pin material: NR
 Pin material: PBT white

MPX - Code 25

Lubricated Acetal

Max w. load: 25500 N/m
 Weight: 8,1 kg/m²
 Temp. range dry: -40÷80 °C
 Temp. range wet: -40÷65 °C
 Pin material: PBT white

Version A - Standard

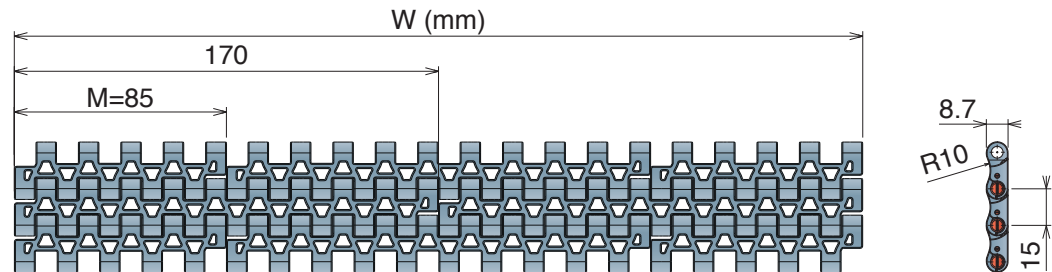

Version B - With 1 Positioner

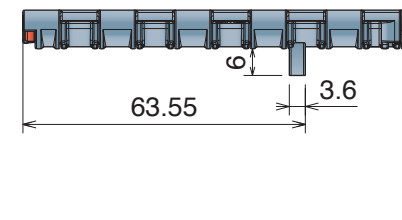

Version C - With 2 Positioner

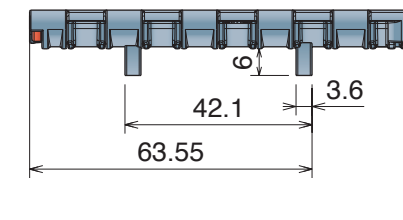

Version A - Standard

Series	Material	Width	Version
5262	*	0085	A
5262	*	0170	A
5262	*	0255	A
5262	*	0340	A
5262	*	0425	A
5262	*	0510	A
5262	*	0595	A
5262	*	0680	A
5262	*	0765	A
5262	*	0850	A
5262	*	0935	A
5262	*	1020	A
5262	*	1105	A
5262	*	1190	A
5262	*	1275	A
5262	*	1360	A
5262	*	1445	A
5262	*	1530	A

Version B - With 1 Positioner

Series	Material	Width	Version
5262	*	0085	B
5262	*	0170	B
5262	*	0255	B
5262	*	0340	B
5262	*	0425	B
5262	*	0510	B
5262	*	0595	B
5262	*	0680	B
5262	*	0765	B
5262	*	0850	B
5262	*	0935	B
5262	*	1020	B
5262	*	1105	B
5262	*	1190	B
5262	*	1275	B
5262	*	1360	B
5262	*	1445	B
5262	*	1530	B

Version C - With 2 Positioners

Series	Material	Width	Version
5262	*	0085	C
5262	*	0170	C
5262	*	0255	C
5262	*	0340	C
5262	*	0425	C
5262	*	0510	C
5262	*	0595	C
5262	*	0680	C
5262	*	0765	C
5262	*	0850	C
5262	*	0935	C
5262	*	1020	C
5262	*	1105	C
5262	*	1190	C
5262	*	1275	C
5262	*	1360	C
5262	*	1445	C
5262	*	1530	C

525 HD GT

Tappeti modulari / Modular belts / Mattenketten

Metric Size

525 HD GT

Tappeto Modulare 525 HD GT, H=8,7 M=85

Modular Belt Series 525 HD GT, H=8,7 M=85 / Modulare Mattenkette 525 HD GT, H=8,7 M=85

CODE STRUCTURE GUIDE

(Example)

5263	03	0340	C
Series	*Material	Width	Version

Backflex radius min.: 25 mm

New



pg. 250



pg. 464->471

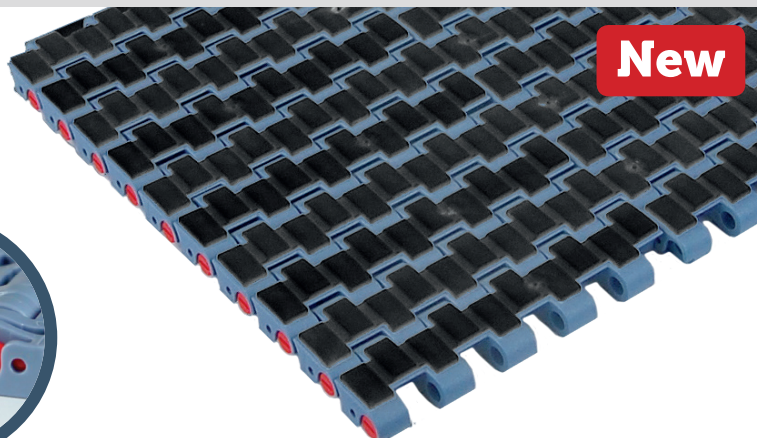
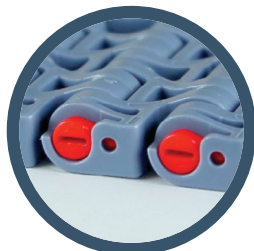

*Material

LFA - Code 01

Low friction Acetal

Max w. load: 25500 N/m
 Weight: 10,35 kg/m²
 Temp. range dry: -40+80 °C
 Temp. range wet: -40+65 °C
 Pin material: PBT white
 Hardness of Grip top Rubber: 75 ShA

PP - Code 02

Polypropylene

Max w. load: 15500 N/m
 Weight: 8,7 kg/m²
 Temp. range dry: 4+80 °C
 Temp. range wet: 4+65 °C
 Pin material: PP blu
 Hardness of Grip top Rubber: 75 ShA

MX - Code 03

Performance PBT

Max w. load: 20500 N/m
 Weight: 10,35 kg/m²
 Temp. range dry: -40+120 °C
 Temp. range wet: -40+60 °C
 Pin material: POM grey
 Hardness of Grip top Rubber: 75 ShA

Available also with
50 ShA Rubber

Version A - Standard

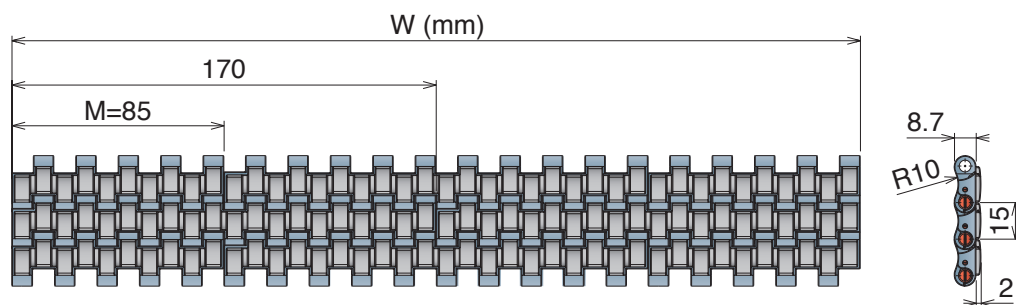

Version B - With 1 Positioner

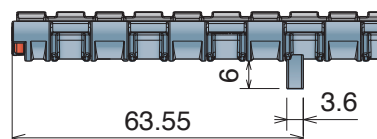

Version C - With 2 Positioners

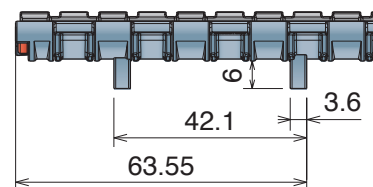

Version A - Standard

Series	Material	Width	Version
5263	*	0085	A
5263	*	0170	A
5263	*	0255	A
5263	*	0340	A
5263	*	0425	A
5263	*	0510	A
5263	*	0595	A
5263	*	0680	A
5263	*	0765	A
5263	*	0850	A
5263	*	0935	A
5263	*	1020	A
5263	*	1105	A
5263	*	1190	A
5263	*	1275	A
5263	*	1360	A
5263	*	1445	A
5263	*	1530	A

Version B - With 1 Positioner

Series	Material	Width	Version
5263	*	0085	B
5263	*	0170	B
5263	*	0255	B
5263	*	0340	B
5263	*	0425	B
5263	*	0510	B
5263	*	0595	B
5263	*	0680	B
5263	*	0765	B
5263	*	0850	B
5263	*	0935	B
5263	*	1020	B
5263	*	1105	B
5263	*	1190	B
5263	*	1275	B
5263	*	1360	B
5263	*	1445	B
5263	*	1530	B

Version C - With 2 Positioners

Series	Material	Width	Version
5263	*	0085	C
5263	*	0170	C
5263	*	0255	C
5263	*	0340	C
5263	*	0425	C
5263	*	0510	C
5263	*	0595	C
5263	*	0680	C
5263	*	0765	C
5263	*	0850	C
5263	*	0935	C
5263	*	1020	C
5263	*	1105	C
5263	*	1190	C
5263	*	1275	C
5263	*	1360	C
5263	*	1445	C
5263	*	1530	C

525 HD GT Side Indent

Tappeto Modulare 525 HD GT Side Indent, H=8,7 M=85
 Modular Belt Series 525 HD GT Side Indent, H=8,7 M=85 / Modulare Mattenkette 525 HD GT Side Indent, H=8,7 M=85

CODE STRUCTURE GUIDE			
(Example)			
5265	03	0340	C
Series	*Material	Width	Version

Backflex radius min.: 25 mm

New

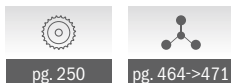

pg. 250

pg. 464->471

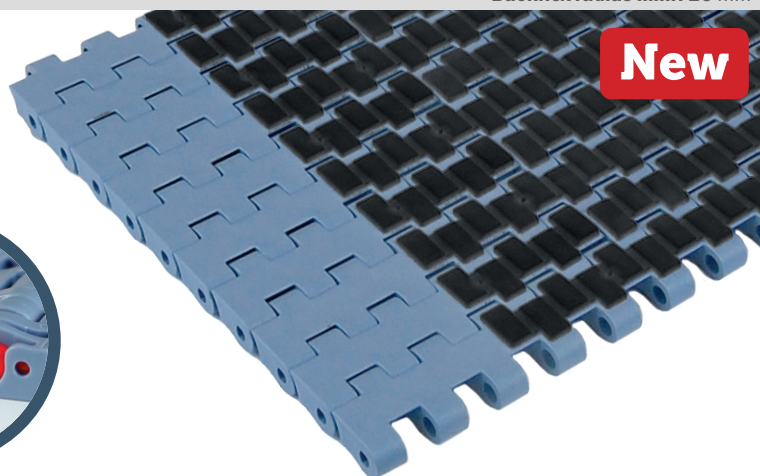
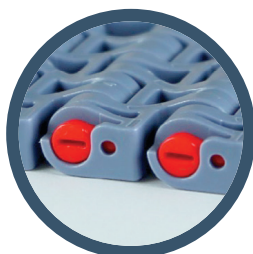

Metric Size

*Material

LFA - Code 01

Low friction Acetal

Max w. load: 25500 N/m
 Weight: 10,35 kg/m²
 Temp. range dry: -40÷80 °C
 Temp. range wet: -40÷65 °C
 Pin material: PBT white
 Hardness of
 Grip top Rubber: 75 Sha

PP - Code 02

Polypropylene

Max w. load: 15500 N/m
 Weight: 8,7 kg/m²
 Temp. range dry: 4÷80 °C
 Temp. range wet: 4÷65 °C
 Pin material: PP blu
 Hardness of
 Grip top Rubber: 75 Sha

MX - Code 03

Performance PBT

Max w. load: 20500 N/m
 Weight: 10,35 kg/m²
 Temp. range dry: -40÷120 °C
 Temp. range wet: -40÷60 °C
 Pin material: POM grey
 Hardness of
 Grip top Rubber: 75 Sha

Version A - Standard

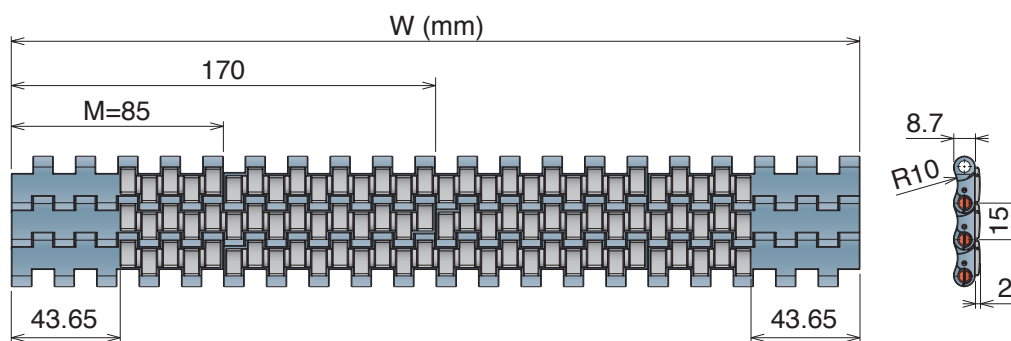

Version B - With 1 Positioner

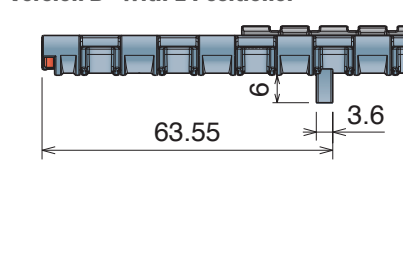

Version C - With 2 Positioner

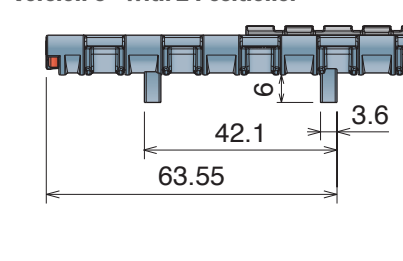

Version A - Standard

Series	Material	Width	Version
5265	*	0255	A
5265	*	0340	A
5265	*	0425	A
5265	*	0510	A
5265	*	0595	A
5265	*	0680	A
5265	*	0765	A
5265	*	0850	A
5265	*	0935	A
5265	*	1020	A
5265	*	1105	A
5265	*	1190	A
5265	*	1275	A
5265	*	1360	A
5265	*	1445	A
5265	*	1530	A

Version B - With 1 Positioner

Series	Material	Width	Version
5265	*	0255	B
5265	*	0340	B
5265	*	0425	B
5265	*	0510	B
5265	*	0595	B
5265	*	0680	B
5265	*	0765	B
5265	*	0850	B
5265	*	0935	B
5265	*	1020	B
5265	*	1105	B
5265	*	1190	B
5265	*	1275	B
5265	*	1360	B
5265	*	1445	B
5265	*	1530	B

Version C - With 2 Positioners

Series	Material	Width	Version
5265	*	0255	C
5265	*	0340	C
5265	*	0425	C
5265	*	0510	C
5265	*	0595	C
5265	*	0680	C
5265	*	0765	C
5265	*	0850	C
5265	*	0935	C
5265	*	1020	C
5265	*	1105	C
5265	*	1190	C
5265	*	1275	C
5265	*	1360	C
5265	*	1445	C
5265	*	1530	C

Available also with
50 Sha Rubber

530

Pitch 15 mm
H= 8,7 mm

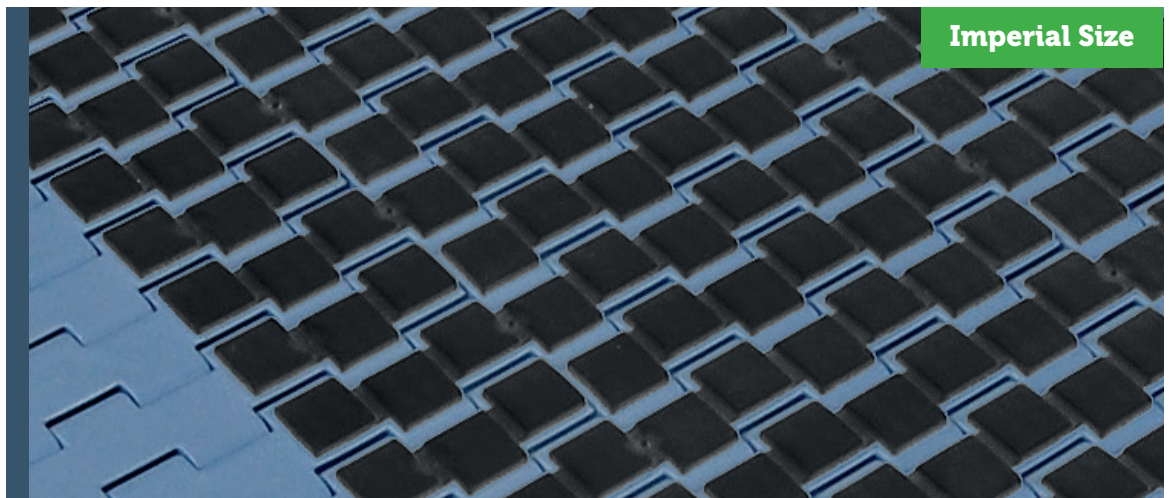

Imperial Size

530 FT
530 FTT
530 GT
530 GT *Side indent*
530 LBP

530 FT

Tappeto Modulare 530 FT, H=8,7 M=3"
 Modular Belt Series 530 FT, H=8,7 M=3" / Modulare Mattenkette 530 FT, H=8,7 M=3"

CODE STRUCTURE GUIDE			
(Example)			
5321	01	0030	A
Series	*Material	Width	Version

Backflex radius min.: 25 mm

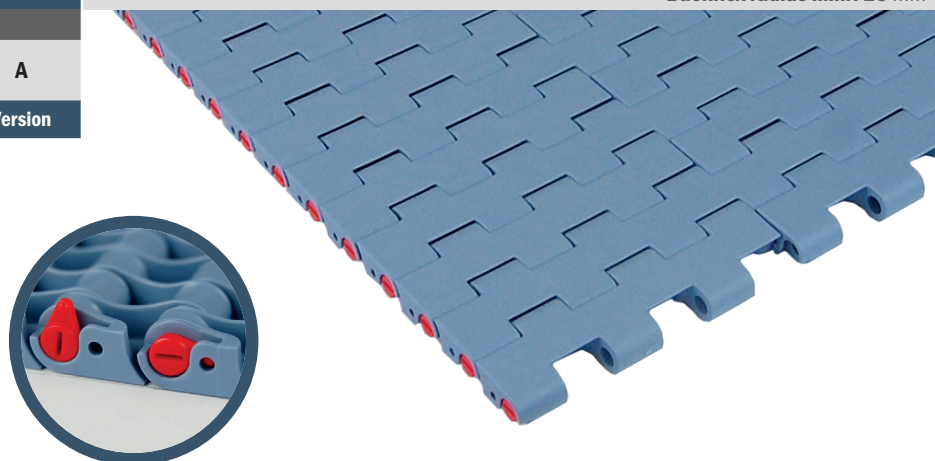
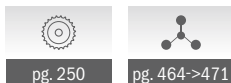

Imperial Size

***Material**

LFA - Code 01

Low friction Acetal

Max w. load: 26000 N/m
 Weight: 9,2 kg/m²
 Temp. range dry: -40÷80 °C
 Temp. range wet: -40÷65 °C
 Pin material: PBT white

MX - Code 03

Performance PBT

Max w. load: 21000 N/m
 Weight: 9,0 kg/m²
 Temp. range dry: -40÷120 °C
 Temp. range wet: -40÷60 °C
 Pin material: POM grey

DKM - Code 16

Aramide Reinforced Acetal

Max w. load: 26000 N/m
 Weight: 9,2 kg/m²
 Temp. range dry: -40÷80 °C
 Temp. range wet: -40÷65 °C
 Pin material: PBT white

MWX - Code 17

Polyamide Composite

Max w. load: 26000 N/m
 Weight: 9,5 kg/m²
 Temp. range dry: -40÷104 °C
 Temp. range wet: NR
 Pin material: PBT white

MPX - Code 25

Lubricated Acetal

Max w. load: 26000 N/m
 Weight: 9,2 kg/m²
 Temp. range dry: -40÷80 °C
 Temp. range wet: -40÷65 °C
 Pin material: PBT white

Version A - Standard

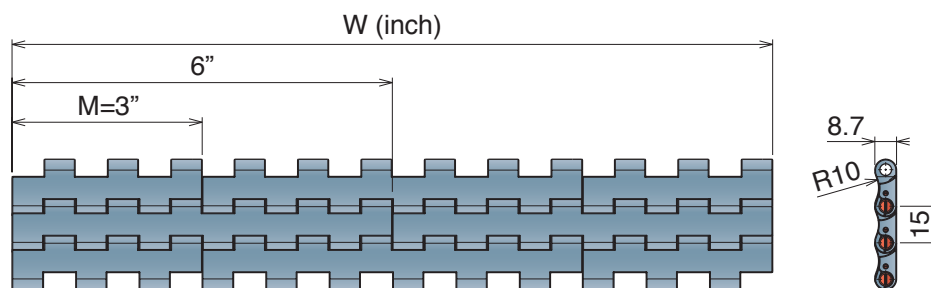

Version A - Standard

Series	Material	Width	Version
5321	*	0003	A
5321	*	0006	A
5321	*	0009	A
5321	*	0012	A
5321	*	0015	A
5321	*	0018	A
5321	*	0021	A
5321	*	0024	A
5321	*	0027	A
5321	*	0030	A
5321	*	0033	A
5321	*	0036	A
5321	*	0039	A
5321	*	0042	A
5321	*	0045	A
5321	*	0048	A
5321	*	0051	A
5321	*	0054	A

530 FTT

Tappeto Modulare 530 FTT, H=8,7 M=3"
 Modular Belt Series 530 FTT, H=8,7 M=3" / Modulare Mattenkette 530 FTT, H=8,7 M=3"

CODE STRUCTURE GUIDE			
(Example)			
5326	01	0006	A
Series	*Material	Width	Version

Backflex radius min.: 25 mm

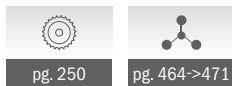

pg. 250

pg. 464->471

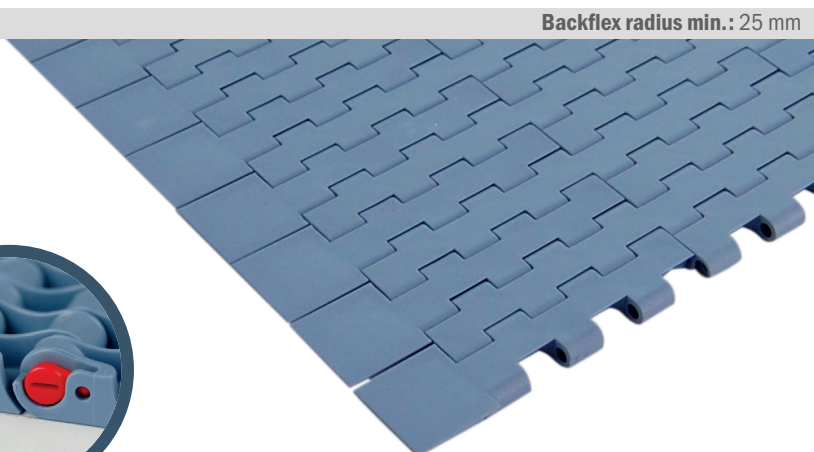
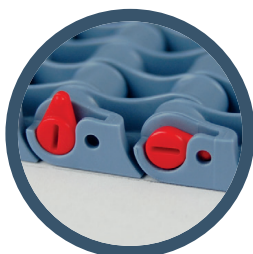

*Material

LFA - Code 01

Low friction Acetal

Max w. load: 26000 N/m
 Weight: 9,2 kg/m²
 Temp. range dry: -40+80 °C
 Temp. range wet: -40+65 °C
 Pin material: PBT white

MX - Code 03

Performance PBT

Max w. load: 21000 N/m
 Weight: 9,0 kg/m²
 Temp. range dry: -40+120 °C
 Temp. range wet: -40+60 °C
 Pin material: POM grey

DKM - Code 16

Aramide Reinforced Acetal

Max w. load: 26000 N/m
 Weight: 9,2 kg/m²
 Temp. range dry: -40+80 °C
 Temp. range wet: -40+65 °C
 Pin material: PBT white

MWX - Code 17

Polyamide Composite

Max w. load: 26000 N/m
 Weight: 9,5 kg/m²
 Temp. range dry: -40+104 °C
 Temp. range wet: NR
 Pin material: PBT white

MPX - Code 25

Lubricated Acetal

Max w. load: 26000 N/m
 Weight: 9,2 kg/m²
 Temp. range dry: -40+80 °C
 Temp. range wet: -40+65 °C
 Pin material: PBT white

Version A - Standard

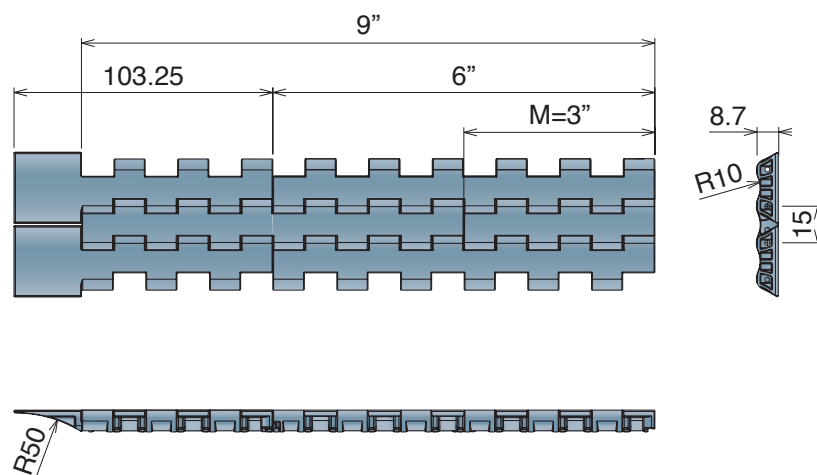

Version A - Standard

Series	Material	Width	Version
5326	*	0003	A
5326	*	0006	A
5326	*	0009	A

530 GT

Tappeto Modulare 530 GT, H=8,7 M=3"
 Modular Belt Series 530 GT, H=8,7 M=3" / Modulare Mattenkette 530 GT, H=8,7 M=3"

CODE STRUCTURE GUIDE

(Example)

5323	01	0009	A
Series	*Material	Width	Version

Backflex radius min.: 30 mm



pg. 250



pg. 464->471

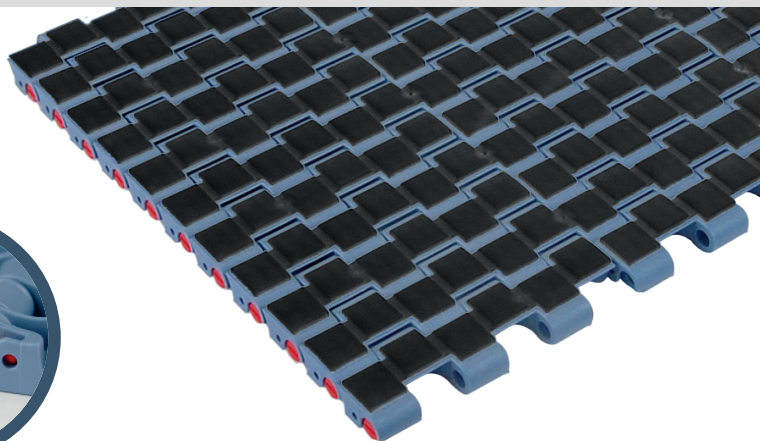
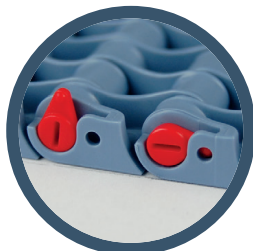

Imperial Size

*Material

LFA - Code 01

Low friction Acetal

Max w. load: 26000 N/m
 Weight: 10,6 kg/m²
 Temp. range dry: -40÷80 °C
 Temp. range wet: -40÷65 °C
 Pin material: PBT white
 Hardness of
 Grip top Rubber: 75 ShA

PP - Code 02

Polypropylene

Max w. load: 16000 N/m
 Weight: 9,0 kg/m²
 Temp. range dry: 4÷80 °C
 Temp. range wet: 4÷65 °C
 Pin material: PP blu
 Hardness of
 Grip top Rubber: 75 ShA

MX - Code 03

Performance PBT

Max w. load: 21000 N/m
 Weight: 10,6 kg/m²
 Temp. range dry: -40÷120 °C
 Temp. range wet: -40÷60 °C
 Pin material: POM grey
 Hardness of
 Grip top Rubber: 75 ShA

Available also with
 50 ShA Rubber

Version A - Standard

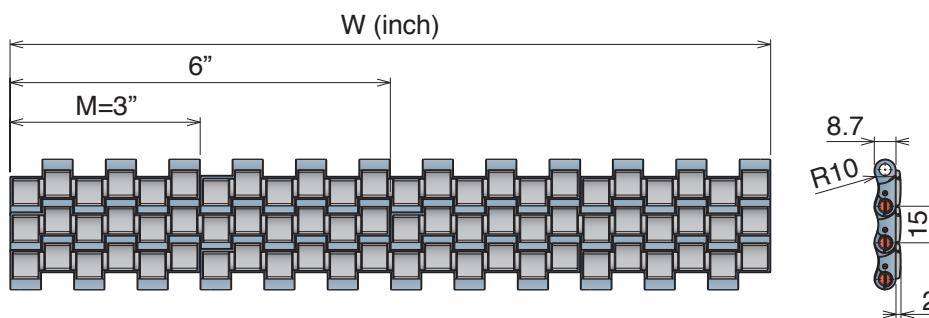

Version A - Standard

Series	Material	Width	Version
5323	*	0003	A
5323	*	0006	A
5323	*	0009	A
5323	*	0012	A
5323	*	0015	A
5323	*	0018	A
5323	*	0021	A
5323	*	0024	A
5323	*	0027	A
5323	*	0030	A
5323	*	0033	A
5323	*	0036	A
5323	*	0039	A
5323	*	0042	A
5323	*	0045	A
5323	*	0048	A
5323	*	0051	A
5323	*	0054	A

530 GT Side indent

Tappeti modulari / Modular belts / Mattenketten

Imperial Size

530 GT Side indent Tappeto Modulare 530 GT, H=8,7 M=3" Modular Belt Series 530 GT, H=8,7 M=3" / Modulare Mattenkette 530 GT, H=8,7 M=3"

CODE STRUCTURE GUIDE

(Example)

5325	01	0027	A
Series	*Material	Width	Version



pg. 250



pg. 464->471

Backflex radius min.: 30 mm

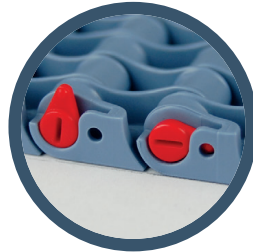
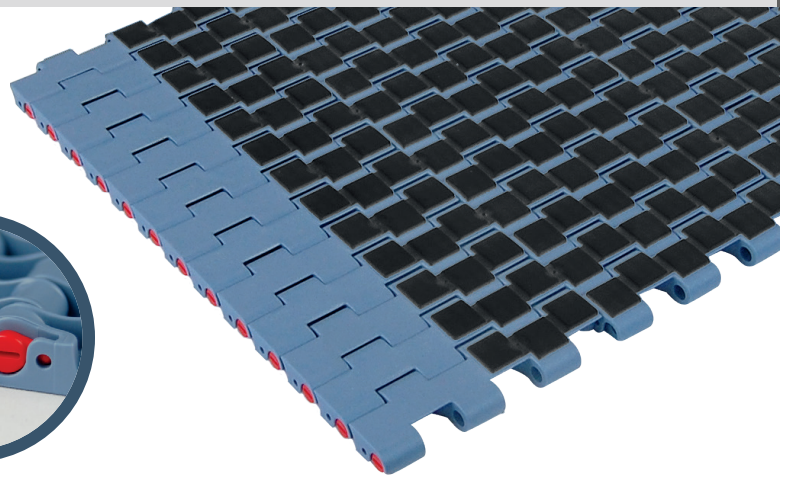

*Material

LFA - Code 01

Low friction Acetal

Max w. load: 26000 N/m
Weight: 10,6 kg/m²
Temp. range dry: -40÷80 °C
Temp. range wet: -40÷65 °C
Pin material: PBT white
Hardness of
Grip top Rubber: 75 ShA

PP - Code 02

Polypropylene

Max w. load: 16000 N/m
Weight: 9,0 kg/m²
Temp. range dry: 4÷80 °C
Temp. range wet: 4÷65 °C
Pin material: PP blu
Hardness of
Grip top Rubber: 75 ShA

MX - Code 03

Performance PBT

Max w. load: 21000 N/m
Weight: 10,6 kg/m²
Temp. range dry: -40÷120 °C
Temp. range wet: -40÷60 °C
Pin material: POM grey
Hardness of
Grip top Rubber: 75 ShA

Available also with
50 ShA Rubber

Version A - Standard

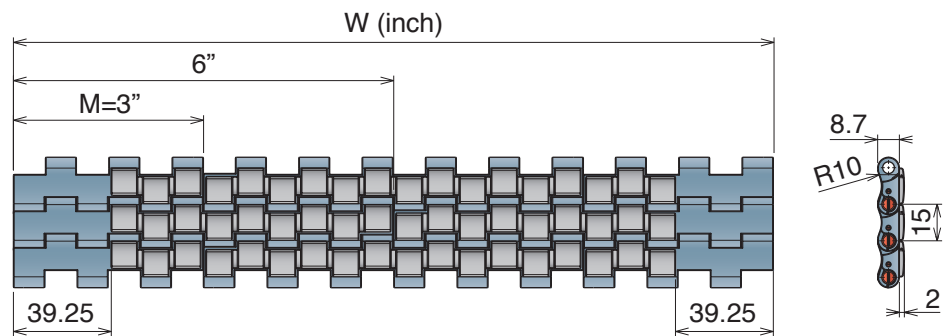

Version A - Standard

Series	Material	Width	Version
5325	*	0009	A
5325	*	0012	A
5325	*	0015	A
5325	*	0018	A
5325	*	0021	A
5325	*	0024	A
5325	*	0027	A
5325	*	0030	A
5325	*	0033	A
5325	*	0036	A
5325	*	0039	A
5325	*	0042	A
5325	*	0045	A
5325	*	0048	A
5325	*	0051	A
5325	*	0054	A

Tappeti modulari / Modular belts / Mattenketten

530 LBP

Tappeto Modulare 530 LBP, H=8,7 M=3"
 Modular Belt Series 530 LBP, H=8,7 M=3" / Modulare Mattenkette 530 LBP, H=8,7 M=3"

CODE STRUCTURE GUIDE			
(Example)			
5324	01	0012	A
Series	*Material	Width	Version

Backflex radius min.: 25 mm



pg. 250



pg. 464->471

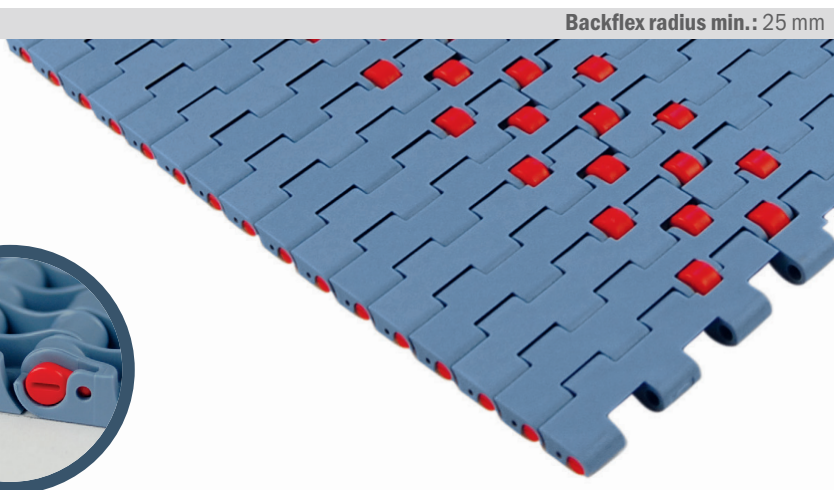
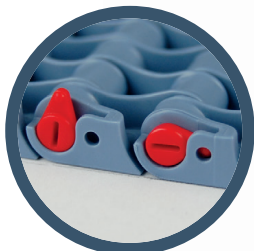

Imperial Size

Version A - Standard

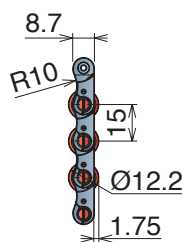
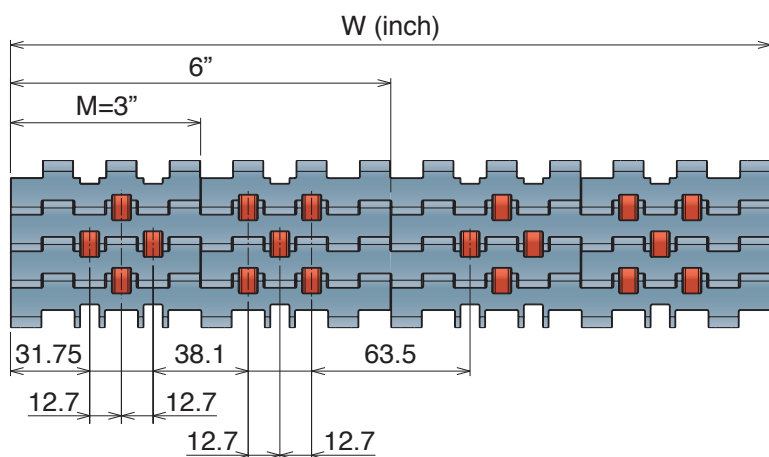

* Material

LFA - Code 01

Low friction Acetal

Max w. load: 26000 N/m
 Weight: 9,2 kg/m²
 Temp. range dry: -40÷80 °C
 Temp. range dry: -40÷65 °C
 Pin material: PBT white

Version A - Standard

Series	Material	Width	Version
5324	*	0006	A
5324	*	0012	A
5324	*	0018	A
5324	*	0024	A
5324	*	0030	A
5324	*	0036	A
5324	*	0042	A
5324	*	0048	A
5324	*	0054	A

550

Pitch 25,4 mm
H= 8,7 mm

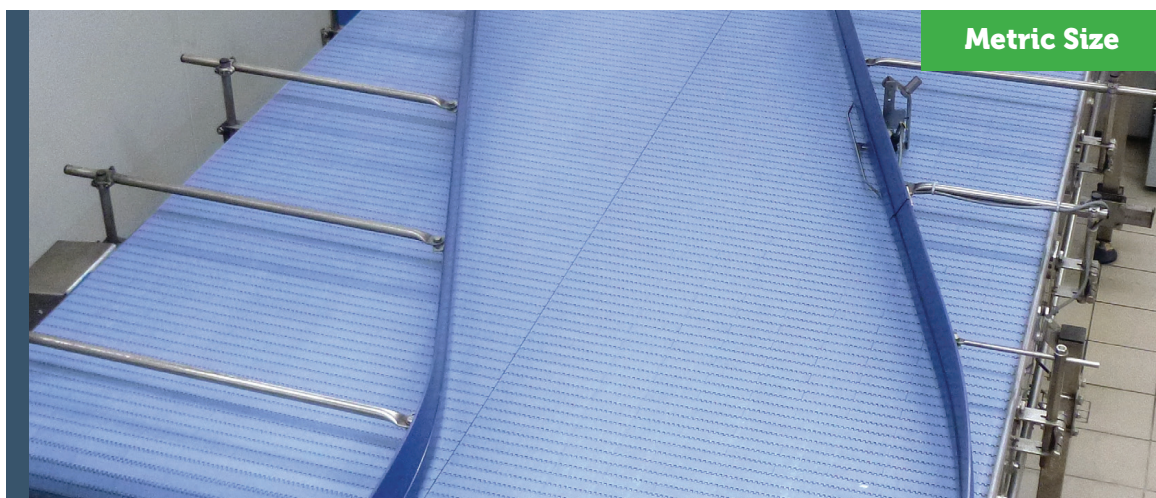

550 FT
550 FT *One track Belt*
550 FTT
530 FG
550 FG *One track Belt*
550 GT

550 GT *Side indent*

550 FT

Tappeto Modulare 550 FT, H=8,7 M=85
 Modular Belt Series 550 FT, H=8,7 M=85 / Modulare Mattenkette 550 FT, H=8,7 M=85

CODE STRUCTURE GUIDE			
(Example)			
5221	01	0255	A
Series	*Material	Width	Version

Backflex radius min.: 25 mm

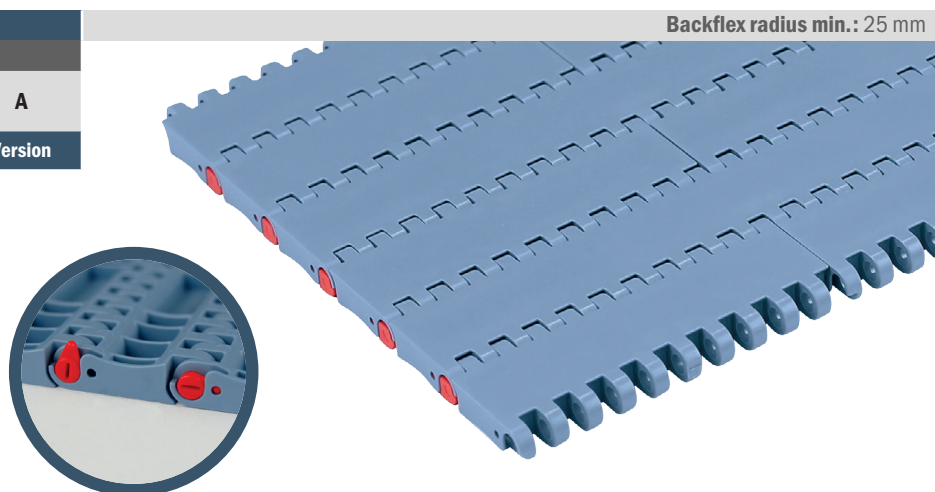

Metric Size

*Material

LFA - Code 01

Low friction Acetal

Max w. load: 27500 N/m
 Weight: 8,5 kg/m²
 Temp. range dry: -40÷80 °C
 Temp. range wet: -40÷65 °C
 Pin material: PBT white

PP - Code 02

Polypropylene

Max w. load: 16500 N/m
 Weight: 8,4 kg/m²
 Temp. range dry: 4÷80 °C
 Temp. range wet: 4÷65 °C
 Pin material: PP blu

MX - Code 03

Performance PBT

Max w. load: 22000 N/m
 Weight: 8,2 kg/m²
 Temp. range dry: -40÷120 °C
 Temp. range wet: -40÷60 °C
 Pin material: POM grey

DKM - Code 16

Aramide Reinforced Acetal

Max w. load: 27500 N/m
 Weight: 8,5 kg/m²
 Temp. range dry: -40÷80 °C
 Temp. range wet: -40÷65 °C
 Pin material: PBT white

MWX - Code 17

Polyamide Composite

Max w. load: 27500 N/m
 Weight: 8,9 kg/m²
 Temp. range dry: -40÷104 °C
 Temp. range wet: NR
 Pin material: PBT white

MPX - Code 25

Lubricated Acetal

Max w. load: 27500 N/m
 Weight: 8,5 kg/m²
 Temp. range dry: -40÷80 °C
 Temp. range wet: -40÷65 °C
 Pin material: PBT white

Version A - Standard

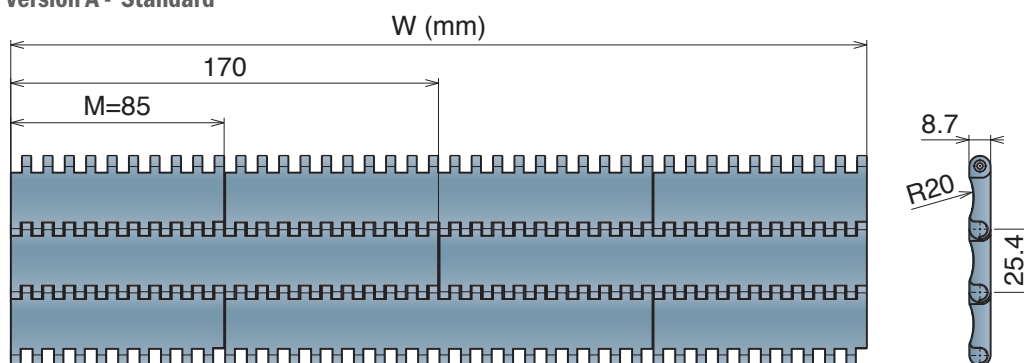

Version B - With 1 Positioner

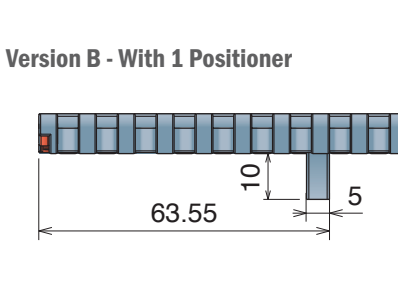

Version C - With 2 Positioner

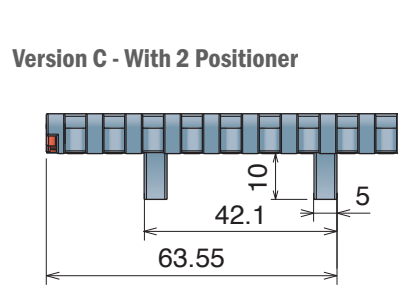

Version A - Standard

Series	Material	Width	Version
5221	*	0085	A
5221	*	0170	A
5221	*	0255	A
5221	*	0340	A
5221	*	0425	A
5221	*	0510	A
5221	*	0595	A
5221	*	0680	A
5221	*	0765	A
5221	*	0850	A
5221	*	0935	A
5221	*	1020	A
5221	*	1105	A
5221	*	1190	A
5221	*	1275	A
5221	*	1360	A
5221	*	1445	A
5221	*	1530	A

Version B - With 1 Positioner

Series	Material	Width	Version
5221	*	0085	B
5221	*	0170	B
5221	*	0255	B
5221	*	0340	B
5221	*	0425	B
5221	*	0510	B
5221	*	0595	B
5221	*	0680	B
5221	*	0765	B
5221	*	0850	B
5221	*	0935	B
5221	*	1020	B
5221	*	1105	B
5221	*	1190	B
5221	*	1275	B
5221	*	1360	B
5221	*	1445	B
5221	*	1530	B

Version C - With 2 Positioners

Series	Material	Width	Version
5221	*	0085	C
5221	*	0170	C
5221	*	0255	C
5221	*	0340	C
5221	*	0425	C
5221	*	0510	C
5221	*	0595	C
5221	*	0680	C
5221	*	0765	C
5221	*	0850	C
5221	*	0935	C
5221	*	1020	C
5221	*	1105	C
5221	*	1190	C
5221	*	1275	C
5221	*	1360	C
5221	*	1445	C
5221	*	1530	C

550 FT One track Belt

Tappeti modulari / Modular belts / Mattenketten

Metric Size

550 FT One track Belt

Tappeto Modulare 550 FT, H=8,7 K330
Modular Belt Series 550 FT, H=8,7 K330 / Modulare Mattenkette 550 FT, H=8,7 K330

CODE STRUCTURE GUIDE

(Example)

5221	03	9330	A
Series	*Material	Width	Version

Backflex radius min.: 25 mm

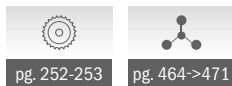

pg. 252-253

pg. 464->471

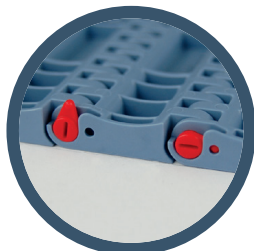
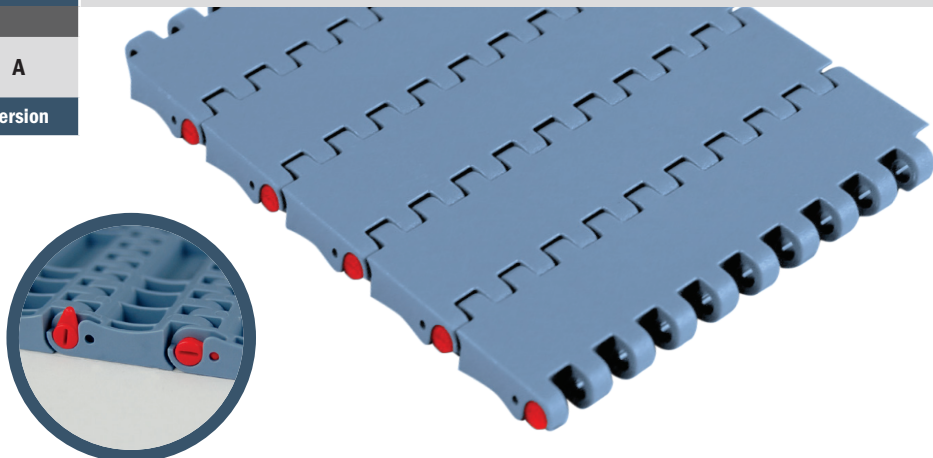

*Material

LFA - Code 01

Low friction Acetal

Max w. load: 27500 N/m
Weight: 8,5 kg/m²
Temp. range dry: -40+80 °C
Temp. range wet: -40+65 °C
Pin material: PBT white

PP - Code 02

Polypropylene

Max w. load: 16500 N/m
Weight: 8,4 kg/m²
Temp. range dry: 4+80 °C
Temp. range wet: 4+65 °C
Pin material: PP blu

MX - Code 03

Performance PBT

Max w. load: 22000 N/m
Weight: 8,2 kg/m²
Temp. range dry: -40+120 °C
Temp. range wet: -40+60 °C
Pin material: POM grey

DKM - Code 16

Aramide Reinforced Acetal

Max w. load: 27500 N/m
Weight: 8,5 kg/m²
Temp. range dry: -40+80 °C
Temp. range wet: -40+65 °C
Pin material: PBT white

MWX - Code 17

Polyamide Composite

Max w. load: 27500 N/m
Weight: 8,9 kg/m²
Temp. range dry: -40+104 °C
Temp. range wet: NR
Pin material: PBT white

MPX - Code 25

Lubricated Acetal

Max w. load: 27500 N/m
Weight: 8,5 kg/m²
Temp. range dry: -40+80 °C
Temp. range wet: -40+65 °C
Pin material: PBT white

Version A - Standard

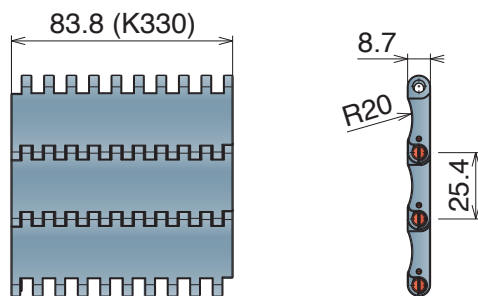

Version C - With 2 Positioner

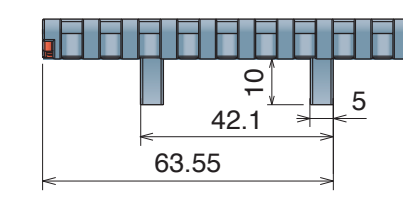

Version A - Standard

Series	Material	Width	Version
5221	*	9330	A

Version C - With 2 Positioners

Series	Material	Width	Version
5221	*	9330	C

550 FTT

Tappeto Modulare 550 FTT, H=8,7 M=85
 Modular Belt Series 550 FTT, H=8,7 M=85 / Modulare Mattenkette 550 FTT, H=8,7 M=85

CODE STRUCTURE GUIDE			
(Example)			
5226	03	0255	CN
Series	*Material	Width	Version

Backflex radius min.: 25 mm



pg. 252-253

pg. 464->471

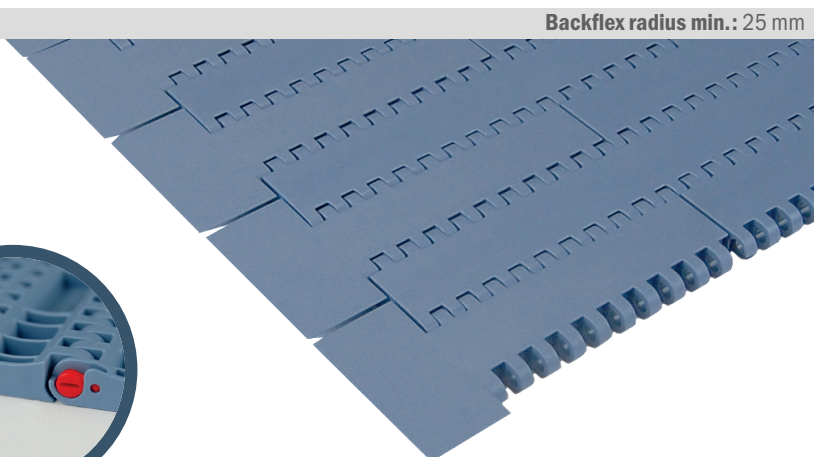
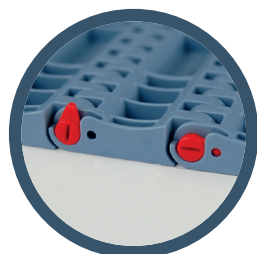

Metric Size

*Material

LFA - Code 01

Low friction Acetal

Max w. load: 27500 N/m
 Weight: 8,5 kg/m²
 Temp. range dry: -40÷80 °C
 Temp. range wet: -40÷65 °C
 Pin material: PBT white

PP - Code 02

Polypropylene

Max w. load: 16500 N/m
 Weight: 8,4 kg/m²
 Temp. range dry: 4÷80 °C
 Temp. range wet: 4÷65 °C
 Pin material: PP blu

MX - Code 03

Performance PBT

Max w. load: 22000 N/m
 Weight: 8,2 kg/m²
 Temp. range dry: -40÷120 °C
 Temp. range wet: -40÷60 °C
 Pin material: POM grey

DKM - Code 16

Aramide Reinforced Acetal

Max w. load: 27500 N/m
 Weight: 8,5 kg/m²
 Temp. range dry: -40÷80 °C
 Temp. range wet: -40÷65 °C
 Pin material: PBT white

MWX - Code 17

Polyamide Composite

Max w. load: 27500 N/m
 Weight: 8,9 kg/m²
 Temp. range dry: -40÷104 °C
 Temp. range wet: NR
 Pin material: PBT white

MPX - Code 25

Lubricated Acetal

Max w. load: 27500 N/m
 Weight: 8,5 kg/m²
 Temp. range dry: -40÷80 °C
 Temp. range wet: -40÷65 °C
 Pin material: PBT white

Version C

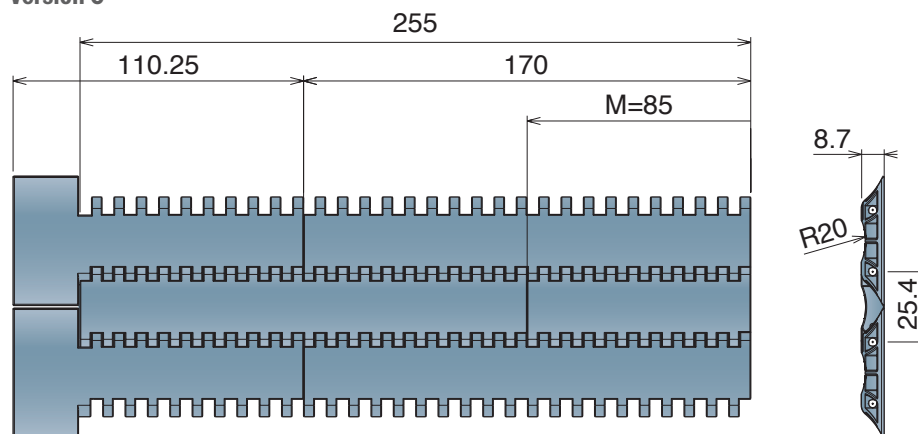

Version CN - Near

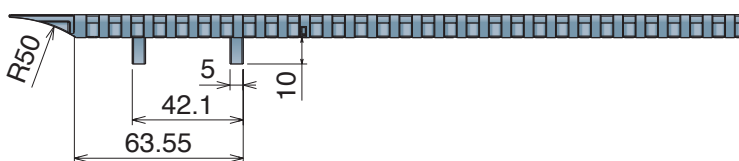

Version C0 - Opposite



Version C

Series	Material	Width	Version
5226	*	0085	C

Version CN - Near

Series	Material	Width	Version
5226	*	0170	CN
5226	*	0255	CN

Version C0 - Opposite

Series	Material	Width	Version
5226	*	0170	C0
5226	*	0255	C0

550 FG

Tappeto Modulare 550 FG, H=8,7 M=85

Modular Belt Series 550 FG, H=8,7 M=85 / Modulare Mattenkette 550 FG, H=8,7 M=85

CODE STRUCTURE GUIDE			
(Example)			
5222	01	0850	C
Series	*Material	Width	Version

Backflex radius min.: 25 mm



pg. 252-253

pg. 464->471

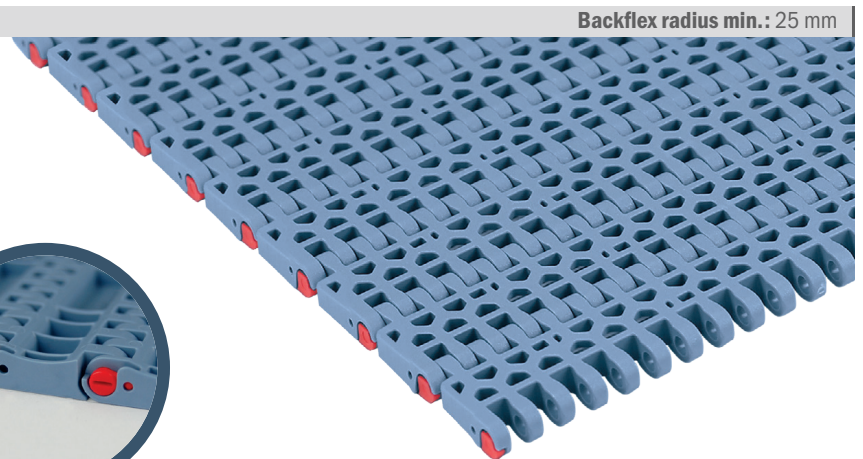
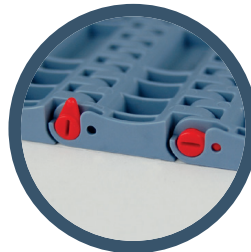

*Material

LFA - Code 01

Low friction Acetal

Max w. load: 27500 N/m
 Weight: 7,0 kg/m²
 Temp. range dry: -40+80 °C
 Temp. range wet: -40+65 °C
 Pin material: PBT white

PP - Code 02

Polypropylene

Max w. load: 16500 N/m
 Weight: 8,4 kg/m²
 Temp. range dry: 4+80 °C
 Temp. range wet: 4+65 °C
 Pin material: PP blu

MX - Code 03

Performance PBT

Max w. load: 22000 N/m
 Weight: 6,7 kg/m²
 Temp. range dry: -40+120 °C
 Temp. range wet: -40+60 °C
 Pin material: POM grey

DKM - Code 16

Aramid Reinforced Acetal

Max w. load: 27500 N/m
 Weight: 7,0 kg/m²
 Temp. range dry: -40+80 °C
 Temp. range wet: -40+65 °C
 Pin material: PBT white

MWX - Code 17

Polyamide Composite

Max w. load: 27500 N/m
 Weight: 7,3 kg/m²
 Temp. range dry: -40+104 °C
 Temp. range wet: NR
 Pin material: PBT white

MPX - Code 25

Lubricated Acetal

Max w. load: 27500 N/m
 Weight: 7,0 kg/m²
 Temp. range dry: -40+80 °C
 Temp. range wet: -40+65 °C
 Pin material: PBT white

Version A - Standard

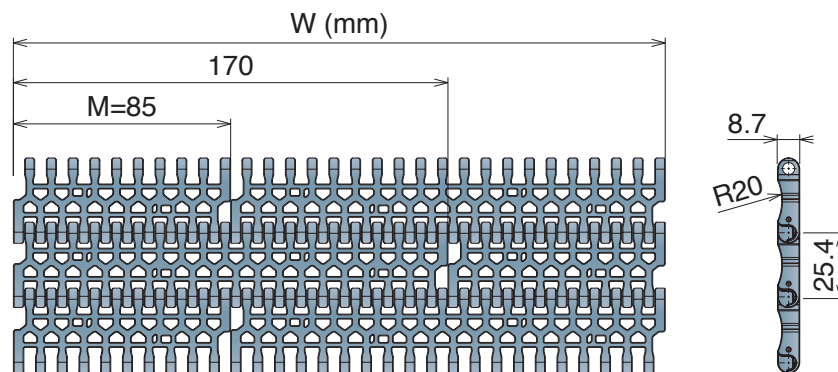

Version B - With 1 Positioner

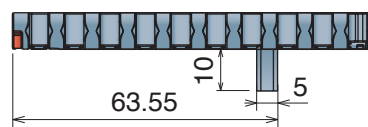

Version C - With 2 Positioners

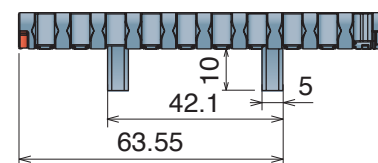

Version A - Standard

Series	Material	Width	Version
5222	*	0085	A
5222	*	0170	A
5222	*	0255	A
5222	*	0340	A
5222	*	0425	A
5222	*	0510	A
5222	*	0595	A
5222	*	0680	A
5222	*	0765	A
5222	*	0850	A
5222	*	0935	A
5222	*	1020	A
5222	*	1105	A
5222	*	1190	A
5222	*	1275	A
5222	*	1360	A
5222	*	1445	A
5222	*	1530	A

Version B - With 1 Positioner

Series	Material	Width	Version
5222	*	0085	B
5222	*	0170	B
5222	*	0255	B
5222	*	0340	B
5222	*	0425	B
5222	*	0510	B
5222	*	0595	B
5222	*	0680	B
5222	*	0765	B
5222	*	0850	B
5222	*	0935	B
5222	*	1020	B
5222	*	1105	B
5222	*	1190	B
5222	*	1275	B
5222	*	1360	B
5222	*	1445	B
5222	*	1530	B

Version C - With 2 Positioners

Series	Material	Width	Version
5222	*	0085	C
5222	*	0170	C
5222	*	0255	C
5222	*	0340	C
5222	*	0425	C
5222	*	0510	C
5222	*	0595	C
5222	*	0680	C
5222	*	0765	C
5222	*	0850	C
5222	*	0935	C
5222	*	1020	C
5222	*	1105	C
5222	*	1190	C
5222	*	1275	C
5222	*	1360	C
5222	*	1445	C
5222	*	1530	C

550 FG One track Belt

Tappeto Modulare 550 FG, H=8,7 K330
Modular Belt Series 550 FG, H=8,7 K330 / Modulare Mattenkette 550 FG, H=8,7 K330

CODE STRUCTURE GUIDE			
(Example)			
5222	01	9330	A
Series	*Material	Width	Version

Backflex radius min.: 25 mm

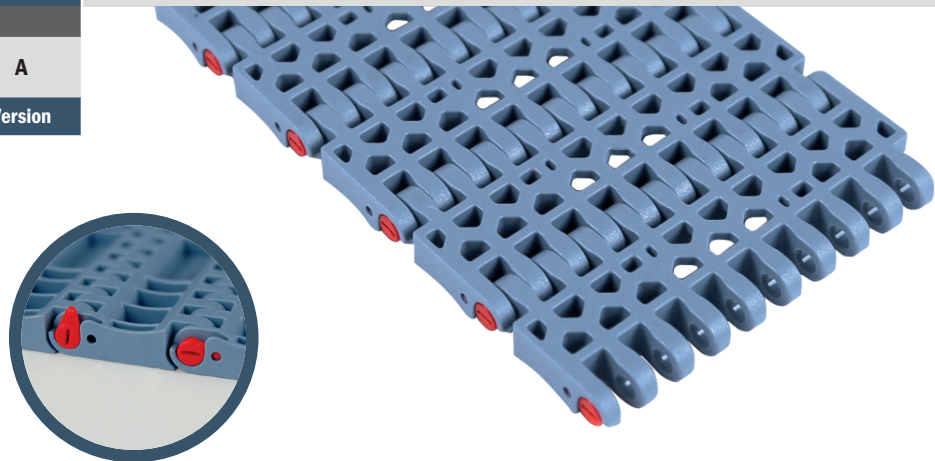
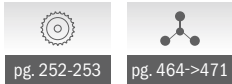

Metric Size

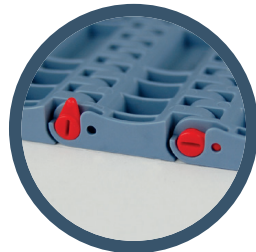

*Material

LFA - Code 01

Low friction Acetal

Max w. load: 27500 N/m
Weight: 7,0 kg/m²
Temp. range dry: -40÷80 °C
Temp. range wet: -40÷65 °C
Pin material: PBT white

PP - Code 02

Polypropylene

Max w. load: 16500 N/m
Weight: 8,4 kg/m²
Temp. range dry: 4÷80 °C
Temp. range wet: 4÷65 °C
Pin material: PP blu

MX - Code 03

Performance PBT

Max w. load: 22000 N/m
Weight: 6,7 kg/m²
Temp. range dry: -40÷120 °C
Temp. range wet: -40÷60 °C
Pin material: POM grey

DKM - Code 16

Aramide Reinforced Acetal

Max w. load: 27500 N/m
Weight: 7,0 kg/m²
Temp. range dry: -40÷80 °C
Temp. range wet: -40÷65 °C
Pin material: PBT white

MWX - Code 17

Polyamide Composite

Max w. load: 27500 N/m
Weight: 7,3 kg/m²
Temp. range dry: -40÷104 °C
Temp. range wet: NR
Pin material: PBT white

MPX - Code 25

Lubricated Acetal

Max w. load: 27500 N/m
Weight: 7,0 kg/m²
Temp. range dry: -40÷80 °C
Temp. range wet: -40÷65 °C
Pin material: PBT white

Version A - Standard

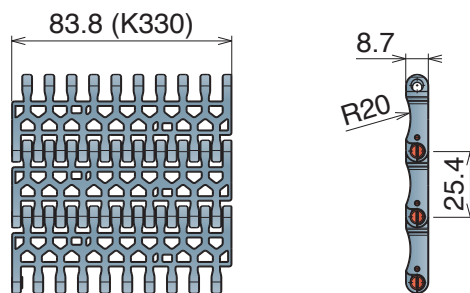

Version C - With 2 Positioner

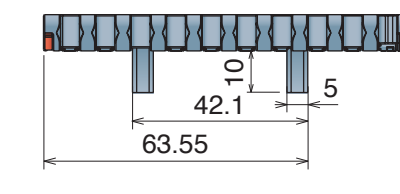

Version A - Standard

Series	Material	Width	Version
5222	*	9330	A

Version C - With 2 Positioners

Series	Material	Width	Version
5222	*	9330	C

550 GT

Tappeti modulari / Modular belts / Mattenketten

Metric Size

550 GT

Tappeto Modulare 550 GT, H=8,7 M=85
Modular Belt Series 550 GT, H=8,7 M=85 / Modulare Mattenkette 550 GT, H=8,7 M=85

CODE STRUCTURE GUIDE

(Example)

5223	02	1020	A
Series	*Material	Width	Version

Backflex radius min.: 30 mm

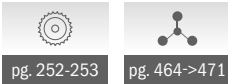

pg. 252-253

pg. 464->471

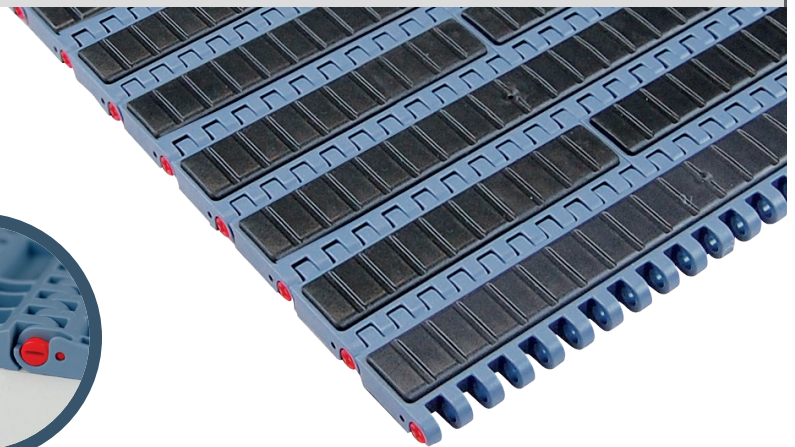
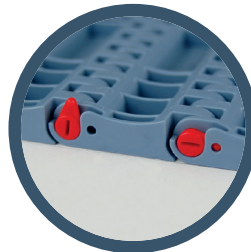

*Material

LFA - Code 01

Low friction Acetal

Max w. load: 27500 N/m
Weight: 10,1 kg/m²
Temp. range dry: -40+80 °C
Temp. range wet: -40+65 °C
Pin material: PBT white
Hardness of
Grip top Rubber: 75 ShA

PP - Code 02

Polypropylene

Max w. load: 16500 N/m
Weight: 8,4 kg/m²
Temp. range dry: 4+80 °C
Temp. range wet: 4+65 °C
Pin material: PP blu
Hardness of
Grip top Rubber: 75 ShA

MX - Code 03

Performance PBT

Max w. load: 21500 N/m
Weight: 10,5 kg/m²
Temp. range dry: -40+120 °C
Temp. range wet: -40+60 °C
Pin material: POM grey
Hardness of
Grip top Rubber: 75 ShA

Available also with
50 ShA Rubber

Version A - Standard

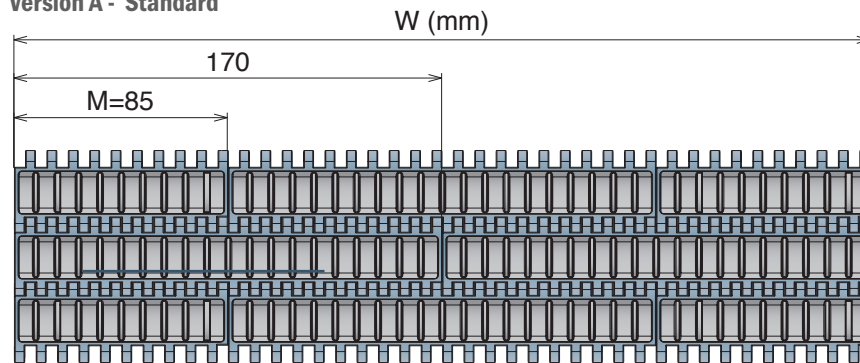

Version B - With 1 Positioner

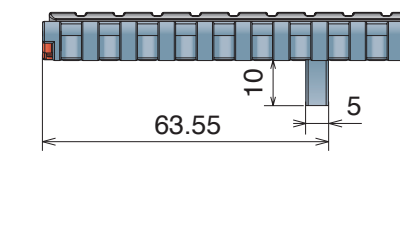

Version C - With 2 Positioners

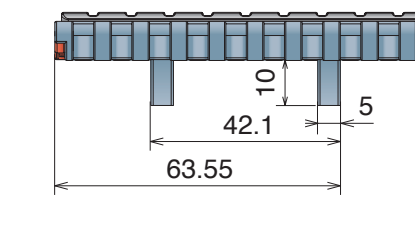

Version A - Standard

Series	Material	Width	Version
5223	*	0085	A
5223	*	0170	A
5223	*	0255	A
5223	*	0340	A
5223	*	0425	A
5223	*	0510	A
5223	*	0595	A
5223	*	0680	A
5223	*	0765	A
5223	*	0850	A
5223	*	0935	A
5223	*	1020	A
5223	*	1105	A
5223	*	1190	A
5223	*	1275	A
5223	*	1360	A
5223	*	1445	A
5223	*	1530	A

Version B - With 1 Positioner

Series	Material	Width	Version
5223	*	0085	B
5223	*	0170	B
5223	*	0255	B
5223	*	0340	B
5223	*	0425	B
5223	*	0510	B
5223	*	0595	B
5223	*	0680	B
5223	*	0765	B
5223	*	0850	B
5223	*	0935	B
5223	*	1020	B
5223	*	1105	B
5223	*	1190	B
5223	*	1275	B
5223	*	1360	B
5223	*	1445	B
5223	*	1530	B

Version C - With 2 Positioners

Series	Material	Width	Version
5223	*	0085	C
5223	*	0170	C
5223	*	0255	C
5223	*	0340	C
5223	*	0425	C
5223	*	0510	C
5223	*	0595	C
5223	*	0680	C
5223	*	0765	C
5223	*	0850	C
5223	*	0935	C
5223	*	1020	C
5223	*	1105	C
5223	*	1190	C
5223	*	1275	C
5223	*	1360	C
5223	*	1445	C
5223	*	1530	C

550 GT Side indent Tappeto Modulare 550 GT, H=8,7 M=85 Modular Belt Series 550 GT, H=8,7 M=85 / Modulare Mattenkette 550 GT, H=8,7 M=85

CODE STRUCTURE GUIDE			
(Example)			
5225	02	0595	B
Series	*Material	Width	Version

Backflex radius min.: 30 mm



pg. 252-253

pg. 464->471

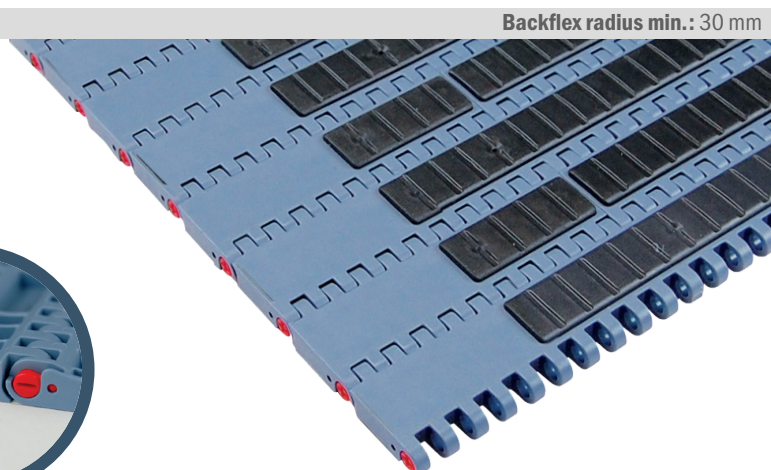
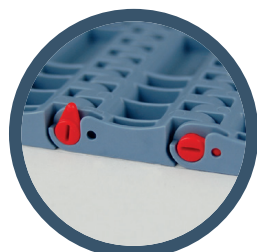

Metric Size

*Material

LFA - Code 01

Low friction Acetal

Max w. load: 27500 N/m
Weight: 10,1 kg/m²
Temp. range dry: -40÷80 °C
Temp. range wet: -40÷65 °C
Pin material: PBT white
Hardness of
Grip top Rubber: 75 Sha

PP - Code 02

Polypropylene

Max w. load: 16500 N/m
Weight: 8,4 kg/m²
Temp. range dry: 4÷80 °C
Temp. range wet: 4÷65 °C
Pin material: PP blu
Hardness of
Grip top Rubber: 75 Sha

MX - Code 03

Performance PBT

Max w. load: 21500 N/m
Weight: 10,5 kg/m²
Temp. range dry: -40÷120 °C
Temp. range wet: -40÷60 °C
Pin material: POM grey
Hardness of
Grip top Rubber: 75 Sha

Available also with
50 Sha Rubber

Version A - Standard

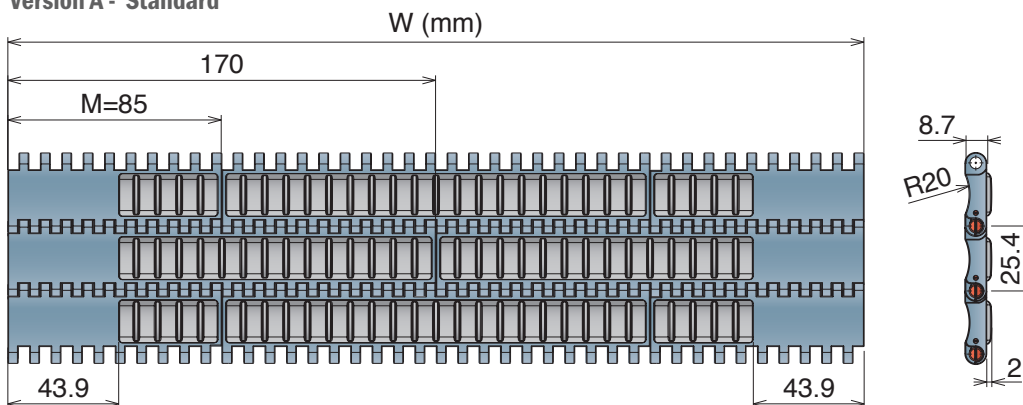

Version B - With 1 Positioner

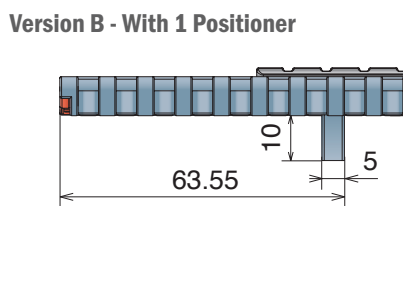

Version C - With 2 Positioners

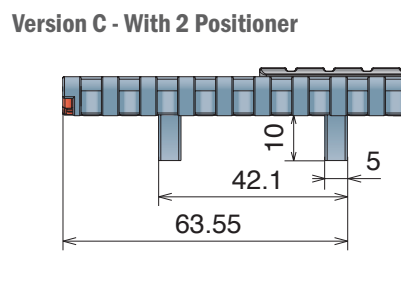

Version A - Standard

Series	Material	Width	Version
5225	*	0255	A
5225	*	0340	A
5225	*	0425	A
5225	*	0510	A
5225	*	0595	A
5225	*	0680	A
5225	*	0765	A
5225	*	0850	A
5225	*	0935	A
5225	*	1020	A
5225	*	1105	A
5225	*	1190	A
5225	*	1275	A
5225	*	1360	A
5225	*	1445	A
5225	*	1530	A

Version B - With 1 Positioner

Series	Material	Width	Version
5225	*	0255	B
5225	*	0340	B
5225	*	0425	B
5225	*	0510	B
5225	*	0595	B
5225	*	0680	B
5225	*	0765	B
5225	*	0850	B
5225	*	0935	B
5225	*	1020	B
5225	*	1105	B
5225	*	1190	B
5225	*	1275	B
5225	*	1360	B
5225	*	1445	B
5225	*	1530	B

Version C - With 2 Positioners

Series	Material	Width	Version
5225	*	0255	C
5225	*	0340	C
5225	*	0425	C
5225	*	0510	C
5225	*	0595	C
5225	*	0680	C
5225	*	0765	C
5225	*	0850	C
5225	*	0935	C
5225	*	1020	C
5225	*	1105	C
5225	*	1190	C
5225	*	1275	C
5225	*	1360	C
5225	*	1445	C
5225	*	1530	C

551 Series

551

Pitch 25,4 mm
H= 12,7 mm

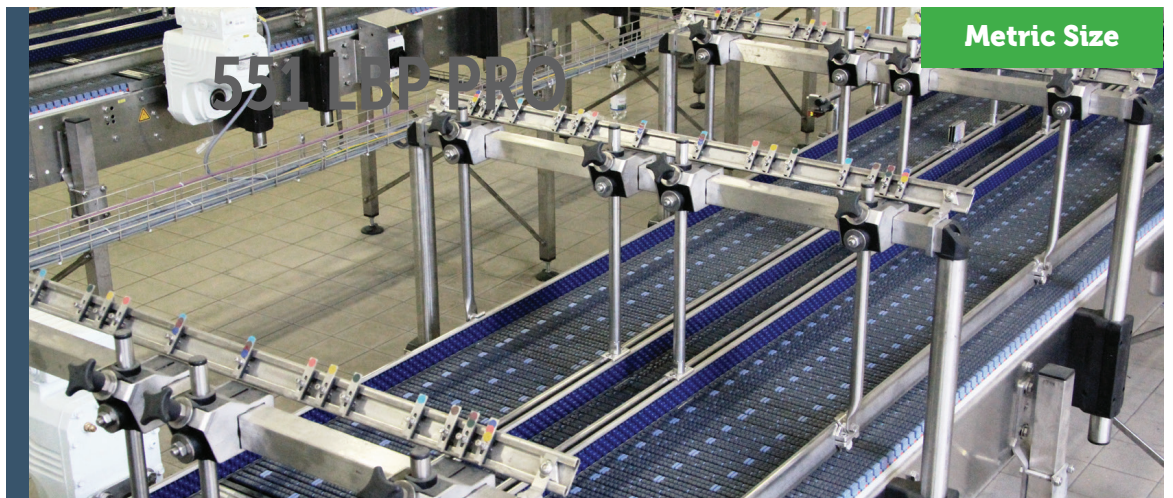

Metric Size

551 LBP PRO

Movex[®]

551 FT
551 FTT
551 GT
551 GT *Side indent*
551 LBP
551 PRO LBP

551 FT

Tappeto Modulare 551 FT, H=12,7 M=85

Modular Belt Series 551 FT, H=12,7 M=85 / Modulare Mattenkette 551 FT, H=12,7 M=85

CODE STRUCTURE GUIDE			
(Example)			
5231	01	0680	C
Series	*Material	Width	Version

Backflex radius min.: 25 mm



pg. 254-255

pg. 464->471

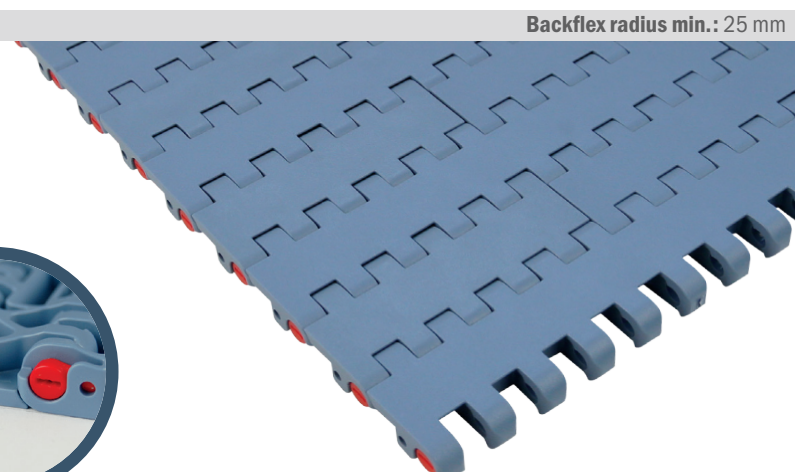

Metric Size

*Material

LFA - Code 01

Low friction Acetal

Max w. load: 41500 N/m
 Weight: 12,5 kg/m²
 Temp. range dry: -40÷80 °C
 Temp. range wet: -40÷65 °C
 Pin material: PBT white

MX - Code 03

Performance PBT

Max w. load: 33500 N/m
 Weight: 12,0 kg/m²
 Temp. range dry: -40÷120 °C
 Temp. range wet: -40÷60 °C
 Pin material: POM grey

DKM - Code 16

Aramide Reinforced Acetal

Max w. load: 41500 N/m
 Weight: 12,5 kg/m²
 Temp. range dry: -40÷80 °C
 Temp. range wet: -40÷65 °C
 Pin material: PBT white

MWX - Code 17

Polyamide Composite

Max w. load: 41500 N/m
 Weight: 13,0 kg/m²
 Temp. range dry: -40÷104 °C
 Temp. range wet: -40÷NR
 Pin material: PBT white

MPX - Code 25

Lubricated Acetal

Max w. load: 41500 N/m
 Weight: 12,5 kg/m²
 Temp. range dry: -40÷80 °C
 Temp. range wet: -40÷65 °C
 Pin material: PBT white

Version A - Standard

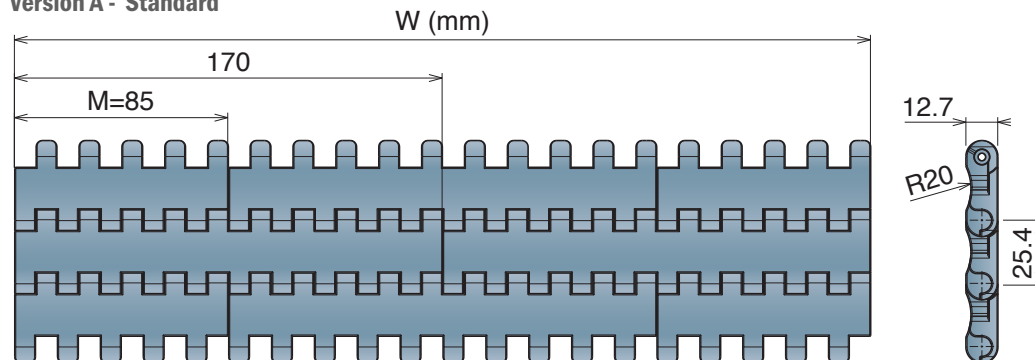

Version B - With 1 Positioner

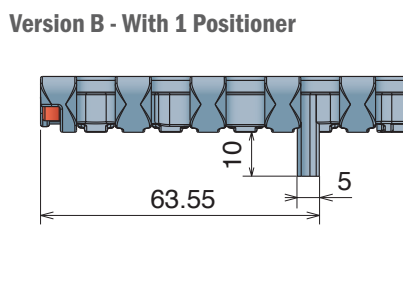

Version C - With 2 Positioners

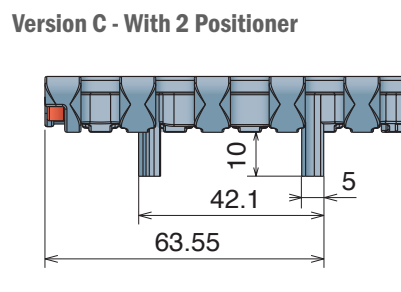

Version A - Standard

Series	Material	Width	Version
5231	*	0085	A
5231	*	0170	A
5231	*	0255	A
5231	*	0340	A
5231	*	0425	A
5231	*	0510	A
5231	*	0595	A
5231	*	0680	A
5231	*	0765	A
5231	*	0850	A
5231	*	0935	A
5231	*	1020	A
5231	*	1105	A
5231	*	1190	A
5231	*	1275	A
5231	*	1360	A
5231	*	1445	A
5231	*	1530	A

Version B - With 1 Positioner

Series	Material	Width	Version
5231	*	0085	B
5231	*	0170	B
5231	*	0255	B
5231	*	0340	B
5231	*	0425	B
5231	*	0510	B
5231	*	0595	B
5231	*	0680	B
5231	*	0765	B
5231	*	0850	B
5231	*	0935	B
5231	*	1020	B
5231	*	1105	B
5231	*	1190	B
5231	*	1275	B
5231	*	1360	B
5231	*	1445	B
5231	*	1530	B

Version C - With 2 Positioners

Series	Material	Width	Version
5231	*	0085	C
5231	*	0170	C
5231	*	0255	C
5231	*	0340	C
5231	*	0425	C
5231	*	0510	C
5231	*	0595	C
5231	*	0680	C
5231	*	0765	C
5231	*	0850	C
5231	*	0935	C
5231	*	1020	C
5231	*	1105	C
5231	*	1190	C
5231	*	1275	C
5231	*	1360	C
5231	*	1445	C
5231	*	1530	C

551 FTT

Tappeto Modulare 551 FTT, H=12,7 M=85

Modular Belt Series 551 FTT, H=12,7 M=85 / Modulare Mattenkette 551 FTT, H=12,7 M=85

CODE STRUCTURE GUIDE			
(Example)			
5236	01	0085	C
Series	*Material	Width	Version

Backflex radius min.: 25 mm



pg. 254-255

pg. 464->471

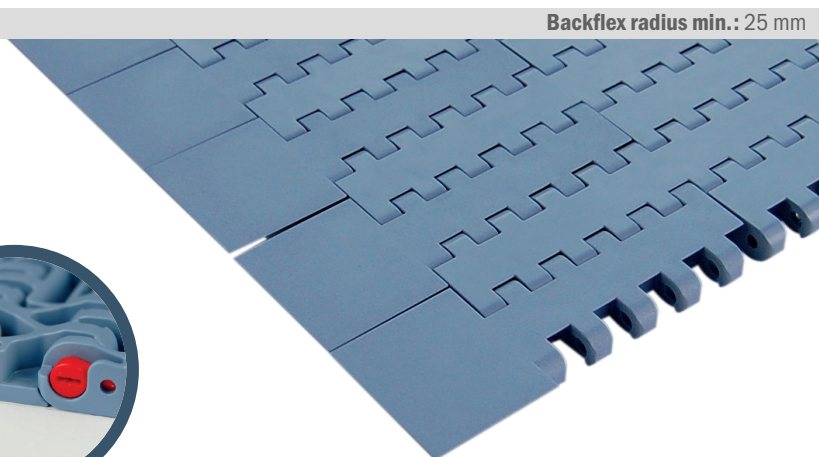
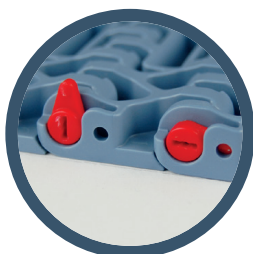

*Material

LFA - Code 01

Low friction Acetal

Max w. load: 41500 N/m
Weight: 12,5 kg/m²
Temp. range dry: -40+80 °C
Temp. range wet: -40+65 °C
Pin material: PBT white

MX - Code 03

Performance PBT

Max w. load: 33500 N/m
Weight: 12,0 kg/m²
Temp. range dry: -40+120 °C
Temp. range wet: -40+60 °C
Pin material: POM grey

DKM - Code 16

Aramide Reinforced Acetal

Max w. load: 41500 N/m
Weight: 12,5 kg/m²
Temp. range dry: -40+80 °C
Temp. range wet: -40+65 °C
Pin material: PBT white

MWX - Code 17

Polyamide Composite

Max w. load: 41500 N/m
Weight: 13,0 kg/m²
Temp. range dry: -40+104 °C
Temp. range wet: NR
Pin material: PBT white

MPX - Code 25

Lubricated Acetal

Max w. load: 41500 N/m
Weight: 12,5 kg/m²
Temp. range dry: -40+80 °C
Temp. range wet: -40+65 °C
Pin material: PBT white

Version C

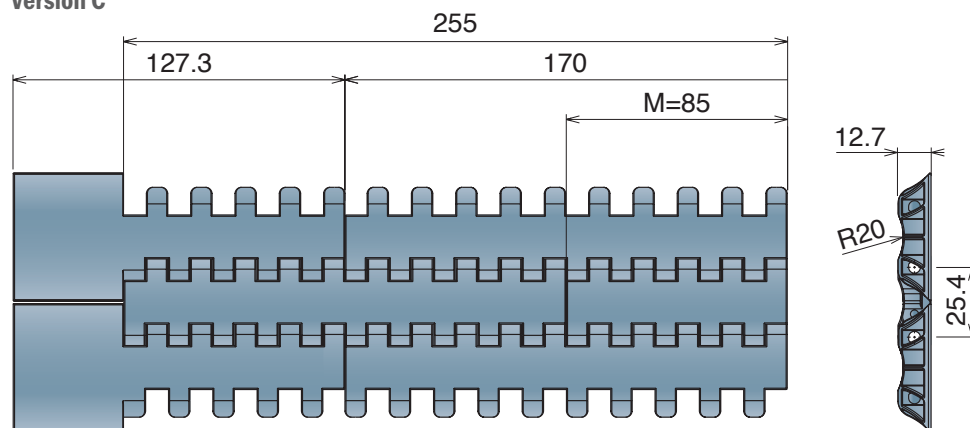

Version CN - Near

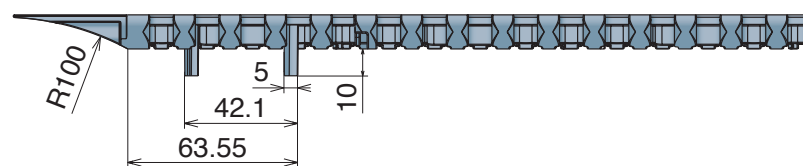

Version CO - Opposite

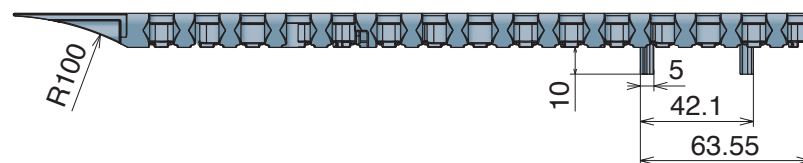

Version C

Series	Material	Width	Version
5236	*	0085	C

Version CN - Near

Series	Material	Width	Version
5236	*	0170	CN
5236	*	0255	CN

Version CO - Opposite

Series	Material	Width	Version
5236	*	0170	CO
5236	*	0255	CO

551 GT

Tappeto Modulare 551 GT, H=12,7 M=85
 Modular Belt Series 551 GT, H=12,7 M=85 / Modulare Mattenkette 551 GT, H=12,7 M=85

CODE STRUCTURE GUIDE			
(Example)			
5233	01	0255	B
Series	*Material	Width	Version

Backflex radius min.: 30 mm



pg. 254-255

pg. 464->471

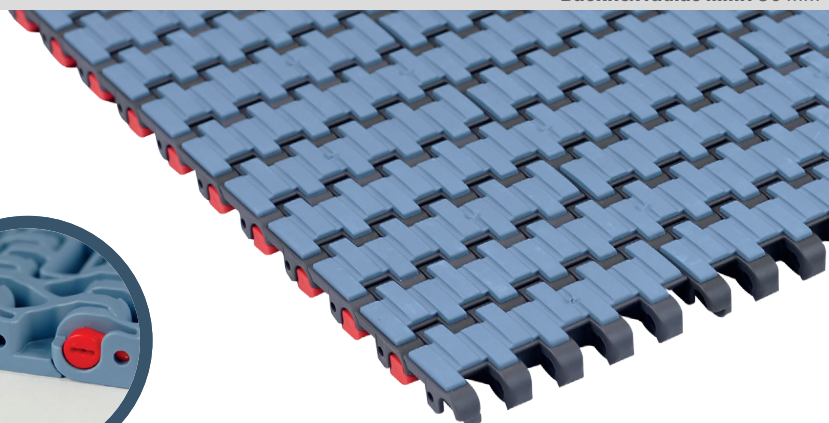
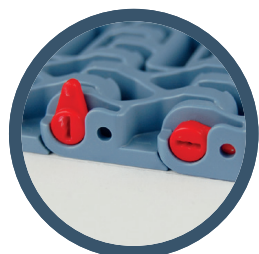

Metric Size

*Material

LFA - Code 01

Low friction Acetal

Max w. load: 41500 N/m
 Weight: 13,5 kg/m²
 Temp. range dry: -40÷80 °C
 Temp. range wet: -40÷65 °C
 Pin material: PBT white
 Hardness of
 Grip top Rubber: 75 Sha

PP - Code 02

Polypropylene

Max w. load: 27000 N/m
 Weight: 11,0 kg/m²
 Temp. range dry: 4÷80 °C
 Temp. range wet: 4÷65 °C
 Pin material: PP blu
 Hardness of
 Grip top Rubber: 75 Sha

MX - Code 03

Performance PBT

Max w. load: 33500 N/m
 Weight: 12,7 kg/m²
 Temp. range dry: -40÷120 °C
 Temp. range wet: -40÷60 °C
 Pin material: POM grey
 Hardness of
 Grip top Rubber: 75 Sha

Version A - Standard

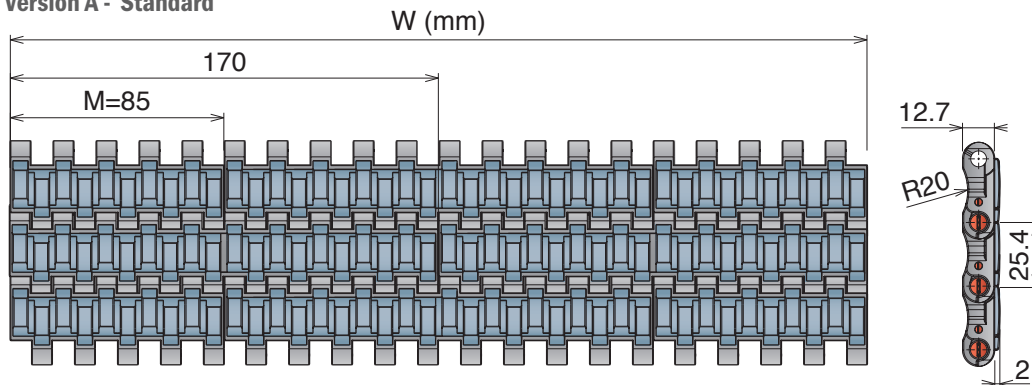

Version B - With 1 Positioner

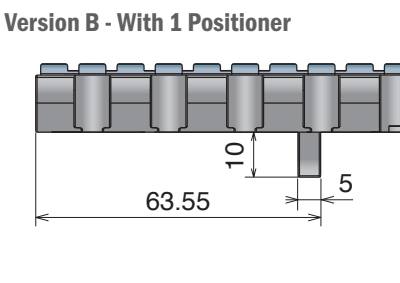

Version C - With 2 Positioners

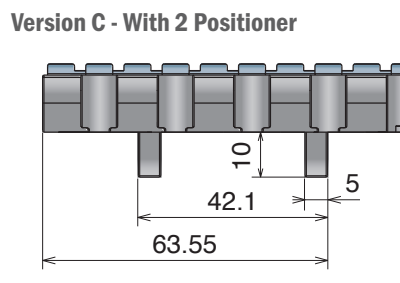

Version A - Standard

Series	Material	Width	Version
5233	*	0085	A
5233	*	0170	A
5233	*	0255	A
5233	*	0340	A
5233	*	0425	A
5233	*	0510	A
5233	*	0595	A
5233	*	0680	A
5233	*	0765	A
5233	*	0850	A
5233	*	0935	A
5233	*	1020	A
5233	*	1105	A
5233	*	1190	A
5233	*	1275	A
5233	*	1360	A
5233	*	1445	A
5233	*	1530	A

Version B - With 1 Positioner

Series	Material	Width	Version
5233	*	0085	B
5233	*	0170	B
5233	*	0255	B
5233	*	0340	B
5233	*	0425	B
5233	*	0510	B
5233	*	0595	B
5233	*	0680	B
5233	*	0765	B
5233	*	0850	B
5233	*	0935	B
5233	*	1020	B
5233	*	1105	B
5233	*	1190	B
5233	*	1275	B
5233	*	1360	B
5233	*	1445	B
5233	*	1530	B

Version C - With 2 Positioners

Series	Material	Width	Version
5233	*	0085	C
5233	*	0170	C
5233	*	0255	C
5233	*	0340	C
5233	*	0425	C
5233	*	0510	C
5233	*	0595	C
5233	*	0680	C
5233	*	0765	C
5233	*	0850	C
5233	*	0935	C
5233	*	1020	C
5233	*	1105	C
5233	*	1190	C
5233	*	1275	C
5233	*	1360	C
5233	*	1445	C
5233	*	1530	C

551 GT Side indent

Tappeti modulari / Modular belts / Mattenketten

Metric Size

551 GT Side indent Tappeto Modulare 551 GT, H=12,7 M=85 Modular Belt Series 551 GT, H=12,7 M=85 / Modulare Mattenkette 551 GT, H=12,7 M=85

CODE STRUCTURE GUIDE			
(Example)			
5235	02	0765	A
Series	*Material	Width	Version

Backflex radius min.: 30 mm

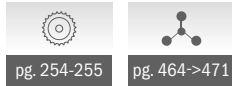

pg. 254-255

pg. 464->471

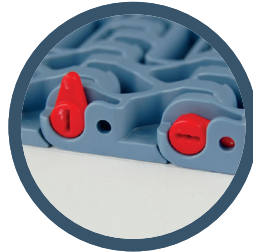
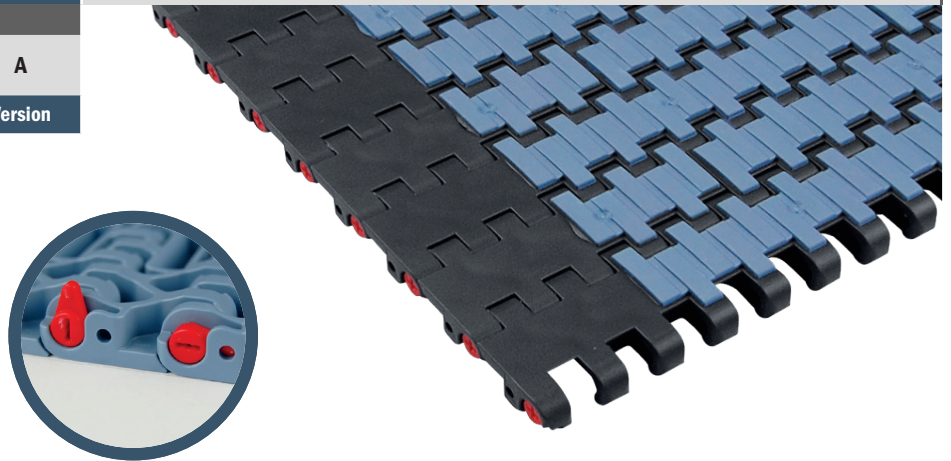

*Material

LFA - Code 01

Low friction Acetal

Max w. load: 41500 N/m
Weight: 13,5 kg/m²
Temp. range dry: -40+80 °C
Temp. range wet: -40+65 °C
Pin material: PBT white
Hardness of
Grip top Rubber: 75 ShA

PP - Code 02

Polypropylene

Max w. load: 27000 N/m
Weight: 11,0 kg/m²
Temp. range dry: 4+80 °C
Temp. range wet: 4+65 °C
Pin material: PP blu
Hardness of
Grip top Rubber: 75 ShA

MX - Code 03

Performance PBT

Max w. load: 33500 N/m
Weight: 12,7 kg/m²
Temp. range dry: -40+120 °C
Temp. range wet: -40+60 °C
Pin material: POM grey
Hardness of
Grip top Rubber: 75 ShA

Version A - Standard

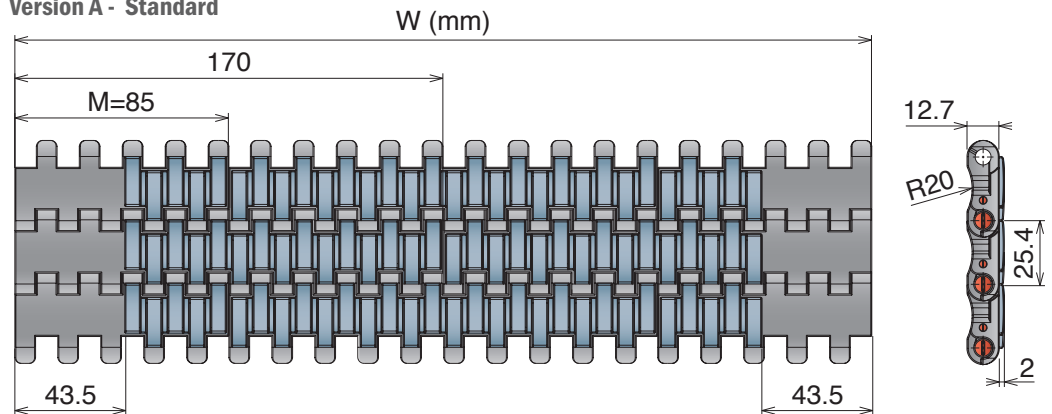

Version B - With 1 Positioner

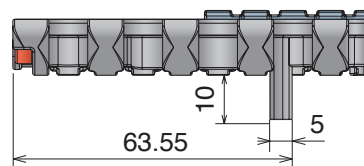

Version C - With 2 Positioner

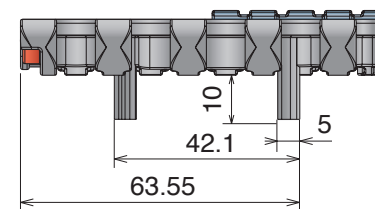

Version A - Standard

Series	Material	Width	Version
5235	*	0255	A
5235	*	0340	A
5235	*	0425	A
5235	*	0510	A
5235	*	0595	A
5235	*	0680	A
5235	*	0765	A
5235	*	0850	A
5235	*	0935	A
5235	*	1020	A
5235	*	1105	A
5235	*	1190	A
5235	*	1275	A
5235	*	1360	A
5235	*	1445	A
5235	*	1530	A

Version B - With 1 Positioner

Series	Material	Width	Version
5235	*	0255	B
5235	*	0340	B
5235	*	0425	B
5235	*	0510	B
5235	*	0595	B
5235	*	0680	B
5235	*	0765	B
5235	*	0850	B
5235	*	0935	B
5235	*	1020	B
5235	*	1105	B
5235	*	1190	B
5235	*	1275	B
5235	*	1360	B
5235	*	1445	B
5235	*	1530	B

Version C - With 2 Positioners

Series	Material	Width	Version
5235	*	0255	C
5235	*	0340	C
5235	*	0425	C
5235	*	0510	C
5235	*	0595	C
5235	*	0680	C
5235	*	0765	C
5235	*	0850	C
5235	*	0935	C
5235	*	1020	C
5235	*	1105	C
5235	*	1190	C
5235	*	1275	C
5235	*	1360	C
5235	*	1445	C
5235	*	1530	C

551 LBP

Tappeto Modulare 551 LBP, H=12,7 M=85
 Modular Belt Series 551 LBP, H=12,7 M=85 / Modulare Mattenkette 551 LBP, H=12,7 M=85

CODE STRUCTURE GUIDE			
(Example)			
5234	01	0425	A
Series	*Material	Width	Version

Backflex radius min.: 120 mm



pg. 254-255

pg. 464->471

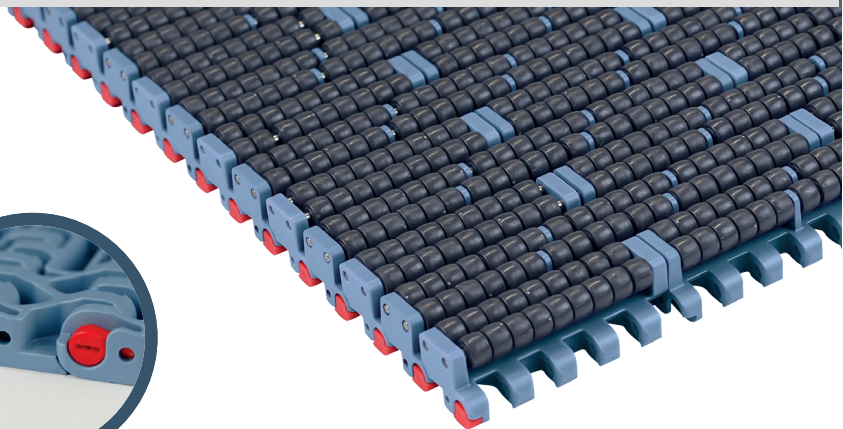
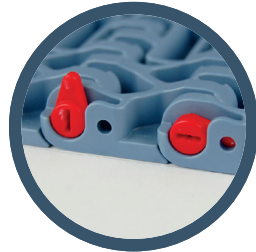

Metric Size

*Material

LFA - Code 01

Low friction Acetal

Max w. load: 41500 N/m
 Weight: 26,9 kg/m²
 Temp. range dry: -40÷80 °C
 Temp. range wet: -40÷65 °C
 Pin material: PBT white

Version A - Standard

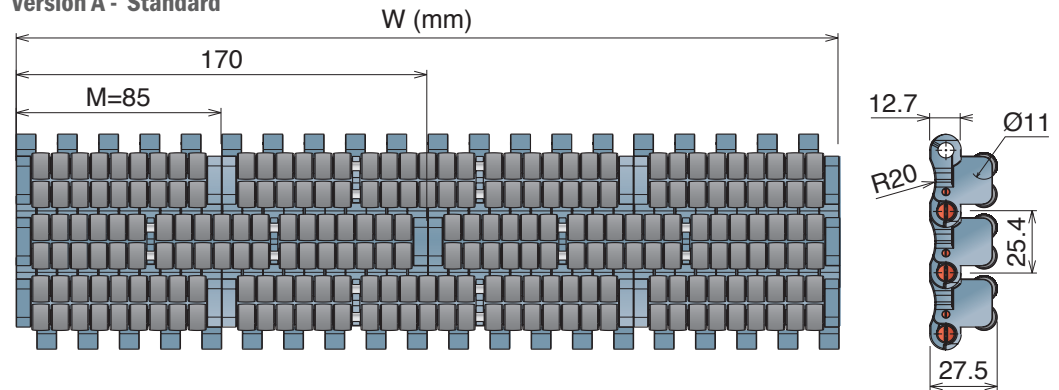

Version B - With 1 Positioner

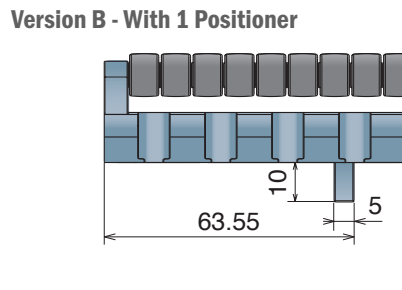

Version C - With 2 Positioner

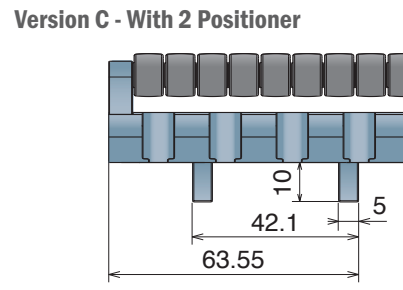

Version A - Standard

Series	Material	Width	Version
5234	*	0085	A
5234	*	0170	A
5234	*	0255	A
5234	*	0340	A
5234	*	0425	A
5234	*	0510	A
5234	*	0595	A
5234	*	0680	A
5234	*	0765	A
5234	*	0850	A
5234	*	0935	A
5234	*	1020	A
5234	*	1105	A
5234	*	1190	A
5234	*	1275	A
5234	*	1360	A
5234	*	1445	A
5234	*	1530	A

Version B - With 1 Positioner

Series	Material	Width	Version
5234	*	0085	B
5234	*	0170	B
5234	*	0255	B
5234	*	0340	B
5234	*	0425	B
5234	*	0510	B
5234	*	0595	B
5234	*	0680	B
5234	*	0765	B
5234	*	0850	B
5234	*	0935	B
5234	*	1020	B
5234	*	1105	B
5234	*	1190	B
5234	*	1275	B
5234	*	1360	B
5234	*	1445	B
5234	*	1530	B

Version C - With 2 Positioners

Series	Material	Width	Version
5234	*	0085	C
5234	*	0170	C
5234	*	0255	C
5234	*	0340	C
5234	*	0425	C
5234	*	0510	C
5234	*	0595	C
5234	*	0680	C
5234	*	0765	C
5234	*	0850	C
5234	*	0935	C
5234	*	1020	C
5234	*	1105	C
5234	*	1190	C
5234	*	1275	C
5234	*	1360	C
5234	*	1445	C
5234	*	1530	C

551 PRO LBP

Modular Belt Series 551 PRO LBP H=12.15 M=85

Energy

25% less energy consumed.
Lower belt weight and smooth rotation of the rollers guarantee minimal backline pressure.

Backline pressure

During accumulation phase, 30% less pressure on the product.

Easy clip

Easy and quick installation and use.

Pins connection

Improved pins and roller connection available pins in Plastic or SS.



Radius in modules

Minimizes chordal action with transfer plate \varnothing 50 mm.

Safe design

Reduces gaps between the rollers for a more secure solution for the chain.

551 PRO LBP, the new concept of accumulation: less noise, smaller in-line transfer area and lighter than the standard LBP chains and belts. These features offer an advantage in energy consumption, reduced friction and noise level.

551 PRO LBP is designed with a finger protection device between the modules.

The Difference with a standard LBP

GAPS BETWEEN ROLLERS

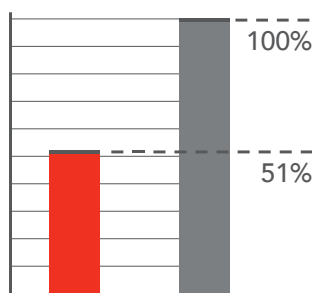

PRO LBP Standard LBP chain

HEADSHAFT TENSION

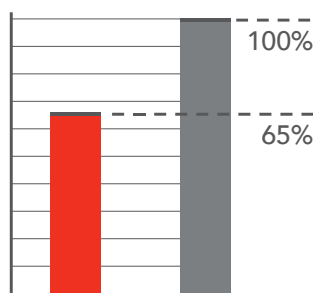

PRO LBP Standard LBP chain

BACKLINE PRESSURE

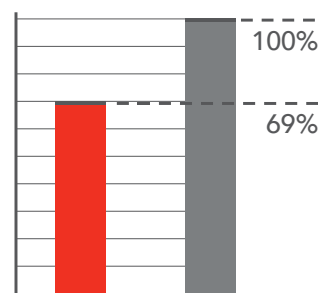

PRO LBP Standard LBP chain



High performance

- -30% Backline pressure
- Improved roller and pins connection
- Smaller head to tail transfers



Best Safety

- Small gaps between rollers, to protect operator
- Permanently fixed roller pins
- Improved low noise



Energy saving

- Low chain weight
- Reduction of friction
- Wearstrips in **BluLub** are recommended

Check with the Movex application department the possibilities to use it.

551 PRO LBP

Tappeto Modulare 551 PRO LBP, H=12,7 M=85
Modular Belt Series 551 PRO LBP, H=12,7 M=85 / Modulare Mattenkette 551 PRO LBP, H=12,7 M=85

CODE STRUCTURE GUIDE			
(Example)			
5237	01	0425	A
Series	*Material	Width	Version

Backflex radius min.: 120 mm

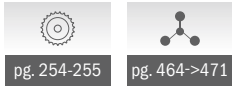

pg. 254-255

pg. 464->471

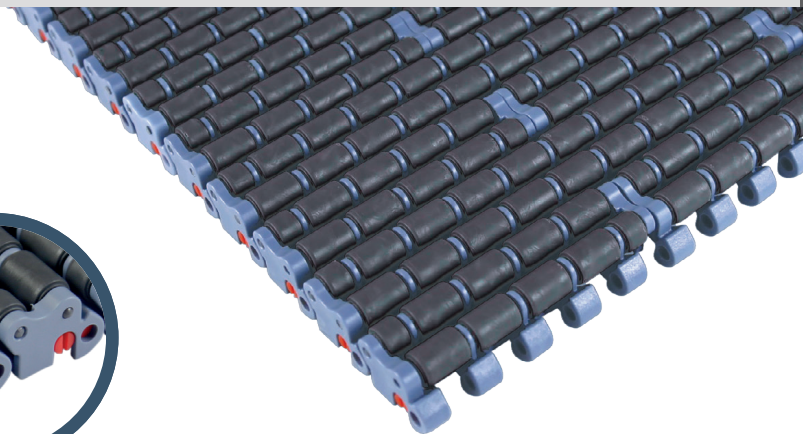
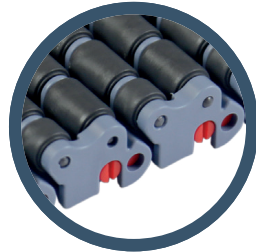

Metric Size

*Material

LFA - Code 01

Low friction Acetal

Max w. load: 41500 N/m
Weight: 26,9 kg/m²
Temp. range dry: -40÷80 °C
Temp. range wet: -40÷65 °C
Pin material: PBT white

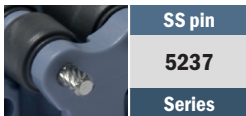

SS pin

5237

Series

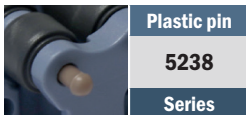

Plastic pin

5238

Series

Patented

Version A - Standard

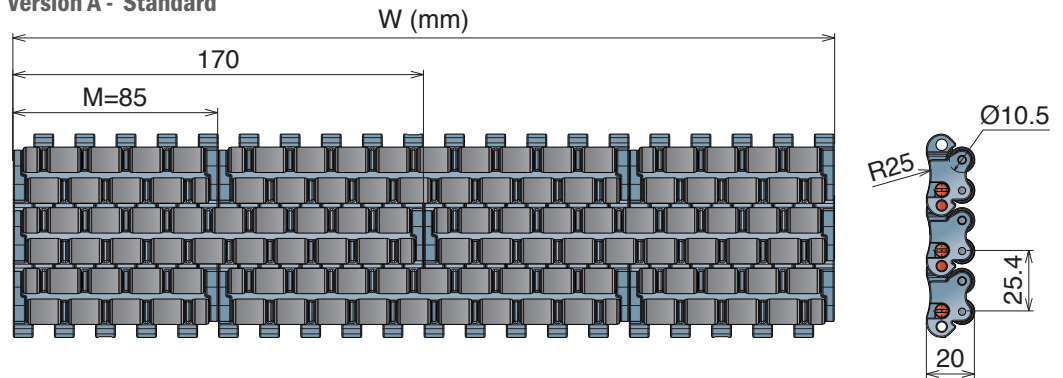

Version B - With 1 Positioner

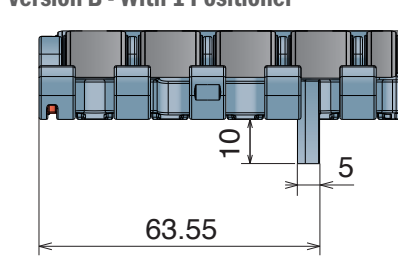

Version C - With 2 Positioner

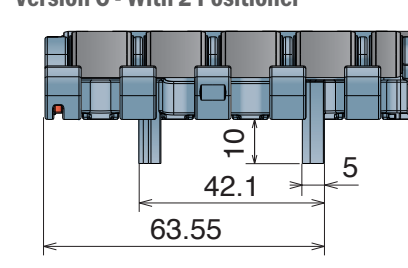

Version A - Standard

Series		Material	Width	Version
SS Pin	Plastic pin			
5237	5238	*	0085	A
5237	5238	*	0170	A
5237	5238	*	0255	A
5237	5238	*	0340	A
5237	5238	*	0425	A
5237	5238	*	0510	A
5237	5238	*	0595	A
5237	5238	*	0680	A
5237	5238	*	0765	A
5237	5238	*	0850	A
5237	5238	*	0935	A
5237	5238	*	1020	A
5237	5238	*	1105	A
5237	5238	*	1190	A
5237	5238	*	1275	A
5237	5238	*	1360	A
5237	5238	*	1445	A
5237	5238	*	1530	A

Version B - With 1 Positioner

Series		Material	Width	Version
SS Pin	Plastic pin			
5237	5238	*	0085	B
5237	5238	*	0170	B
5237	5238	*	0255	B
5237	5238	*	0340	B
5237	5238	*	0425	B
5237	5238	*	0510	B
5237	5238	*	0595	B
5237	5238	*	0680	B
5237	5238	*	0765	B
5237	5238	*	0850	B
5237	5238	*	0935	B
5237	5238	*	1020	B
5237	5238	*	1105	B
5237	5238	*	1190	B
5237	5238	*	1275	B
5237	5238	*	1360	B
5237	5238	*	1445	B
5237	5238	*	1530	B

Version C - With 2 Positioners

Series		Material	Width	Version
SS Pin	Plastic pin			
5237	5238	*	0085	C
5237	5238	*	0170	C
5237	5238	*	0255	C
5237	5238	*	0340	C
5237	5238	*	0425	C
5237	5238	*	0510	C
5237	5238	*	0595	C
5237	5238	*	0680	C
5237	5238	*	0765	C
5237	5238	*	0850	C
5237	5238	*	0935	C
5237	5238	*	1020	C
5237	5238	*	1105	C
5237	5238	*	1190	C
5237	5238	*	1275	C
5237	5238	*	1360	C
5237	5238	*	1445	C
5237	5238	*	1530	C

552

Pitch 25,4 mm
H= 12,7 mm



552 FT
552 FT *One track Belt*
552 FTT
552 PT
552 PT *One track Belt*
552 GT

552 GT *Side indent*

552 FT

Tappeto Modulare 552 FT, H=12,7 M=3"
 Modular Belt Series 552 FT, H=12,7 M=3" / Modulare Mattenkette 552 FT, H=12,7 M=3"

CODE STRUCTURE GUIDE			
(Example)			
5341	01	0021	A
Series	*Material	Width	Version

Backflex radius min.: 25 mm



pg. 256

pg. 464->471

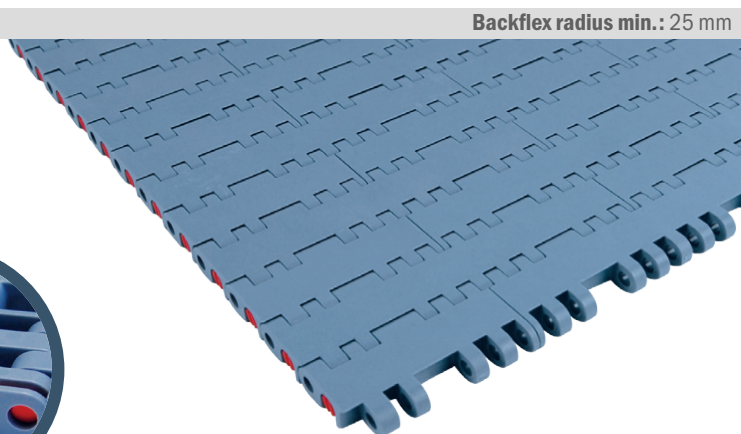

Imperial Size

*Material

LFA - Code 01

Low friction Acetal

Max w. load: 41500 N/m
 Weight: 13,5 kg/m²
 Temp. range dry: -40÷80 °C
 Temp. range wet: -40÷65 °C
 Pin material: PBT white

MX - Code 03

Performance PBT

Max w. load: 33500 N/m
 Weight: 13,0 kg/m²
 Temp. range dry: -40÷120 °C
 Temp. range wet: -40÷60 °C
 Pin material: POM grey

DKM - Code 16

Aramide Reinforced Acetal

Max w. load: 41500 N/m
 Weight: 13,5 kg/m²
 Temp. range dry: -40÷80 °C
 Temp. range wet: -40÷65 °C
 Pin material: PBT white

MWX - Code 17

Polyamide Composite

Max w. load: 41500 N/m
 Weight: 14,0 kg/m²
 Temp. range dry: -40÷104 °C
 Temp. range wet: NR
 Pin material: PBT white

MPX - Code 25

Lubricated Acetal

Max w. load: 41500 N/m
 Weight: 13,5 kg/m²
 Temp. range dry: -40÷80 °C
 Temp. range wet: -40÷65 °C
 Pin material: PBT white

Version A - Standard

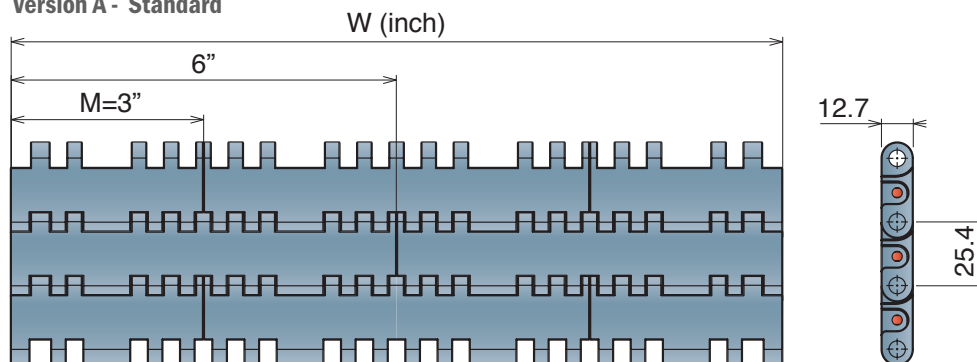

Version A - Standard

Series	Material	Width	Version
5341	*	0009	A
5341	*	0012	A
5341	*	0015	A
5341	*	0018	A
5341	*	0021	A
5341	*	0024	A
5341	*	0027	A
5341	*	0030	A
5341	*	0033	A
5341	*	0036	A
5341	*	0039	A
5341	*	0042	A
5341	*	0045	A
5341	*	0048	A
5341	*	0051	A
5341	*	0054	A

552 FT One track Belt

Tappeti modulari / Modular belts / Mattenketten

Imperial Size

552 FT One track Belt

Tappeto Modulare 552 FT, H=12,7
Modular Belt Series 552 FT, H=12,7 / Modulare Mattenkette 552 FT, H=12,7

CODE STRUCTURE GUIDE			
(Example)			
5341	01	0003	A
Series	*Material	Width	Version

Backflex radius min.: 25 mm

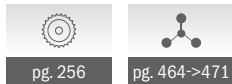

pg. 256

pg. 464->471

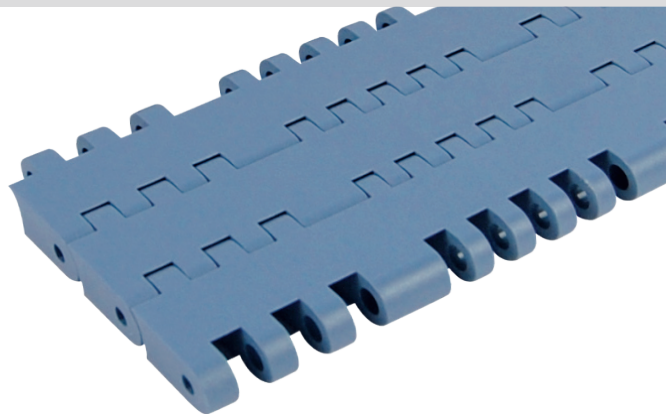
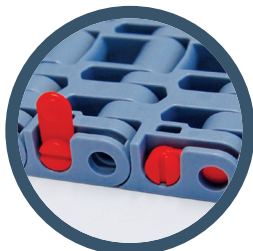

*Material

LFA - Code 01

Low friction Acetal

Max w. load: 41500 N/m
Weight: 13,5 kg/m²
Temp. range dry: -40+80 °C
Temp. range wet: -40+65 °C
Pin material: PBT white

MX - Code 03

Performance PBT

Max w. load: 33500 N/m
Weight: 13,0 kg/m²
Temp. range dry: -40+120 °C
Temp. range wet: -40+60 °C
Pin material: POM grey

DKM - Code 16

Aramide Reinforced Acetal

Max w. load: 41500 N/m
Weight: 13,5 kg/m²
Temp. range dry: -40+80 °C
Temp. range wet: -40+65 °C
Pin material: PBT white

MWX - Code 17

Polyamide Composite

Max w. load: 41500 N/m
Weight: 14,0 kg/m²
Temp. range dry: -40+104 °C
Temp. range wet: NR
Pin material: PBT white

MPX - Code 25

Lubricated Acetal

Max w. load: 41500 N/m
Weight: 13,5 kg/m²
Temp. range dry: -40+80 °C
Temp. range wet: -40+65 °C
Pin material: PBT white

Version A - Standard

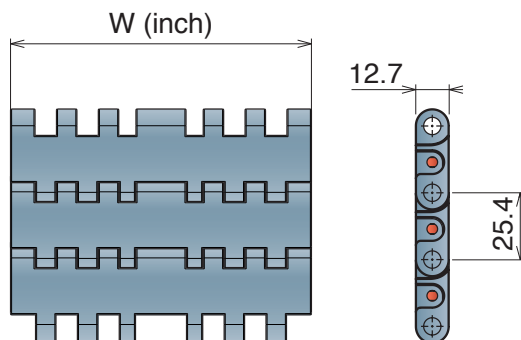

Version C - With 2 Positioner

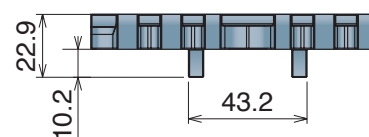

Version A/C

One track belt

Series	Material	Width	Version
5341	*	0003	A
5341	*	0006	A
5341	*	0003	C
5341	*	0006	C

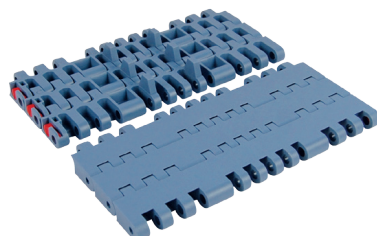
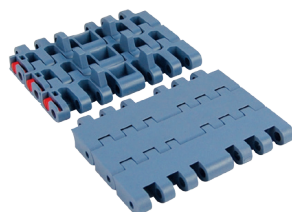
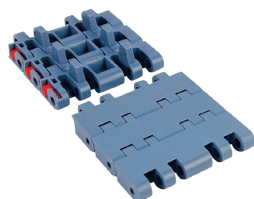

K325 - One track belt

Series	Material	Width	Version
5341	*	9325	A
5341	*	9325	C

K450 - One track belt

Series	Material	Width	Version
5341	*	9450	A
5341	*	9450	C

K750 - One track belt

Series	Material	Width	Version
5341	*	9750	A
5341	*	9750	C

Tappeti modulari / Modular belts / Mattenketten

552 FTT

Tappeto Modulare 552 FTT, H=12,7
 Modular Belt Series 552 FTT, H=12,7 / Modulare Mattenkette 552 FTT, H=12,7

CODE STRUCTURE GUIDE			
(Example)			
5346	01	9450	C-R
Series	*Material	Width	Version

Backflex radius min.: 25 mm

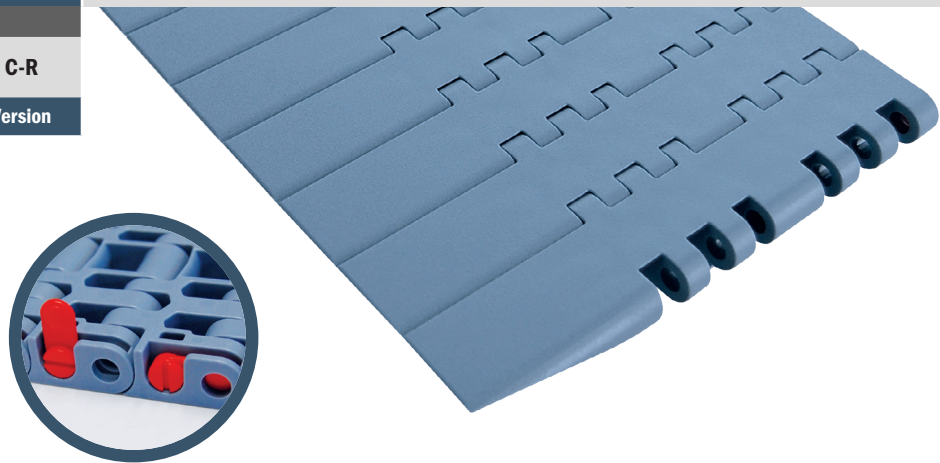
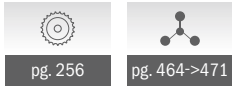

Imperial Size

*Material

LFA - Code 01

Low friction Acetal

Max w. load: 41500 N/m
 Weight: 13,5 kg/m²
 Temp. range dry: -40÷80 °C
 Temp. range wet: -40÷65 °C
 Pin material: PBT white

MX - Code 03

Performance PBT

Max w. load: 33500 N/m
 Weight: 13,0 kg/m²
 Temp. range dry: -40÷120 °C
 Temp. range wet: -40÷60 °C
 Pin material: POM grey

DKM - Code 16

Aramid Reinforced Acetal

Max w. load: 41500 N/m
 Weight: 13,5 kg/m²
 Temp. range dry: -40÷80 °C
 Temp. range wet: -40÷65 °C
 Pin material: PBT white

MWX - Code 17

Polyamide Composite

Max w. load: 41500 N/m
 Weight: 14,0 kg/m²
 Temp. range dry: -40÷104 °C
 Temp. range wet: NR
 Pin material: PBT white

MPX - Code 25

Lubricated Acetal

Max w. load: 41500 N/m
 Weight: 13,5 kg/m²
 Temp. range dry: -40÷80 °C
 Temp. range wet: -40÷65 °C
 Pin material: PBT white

552 FTT - DX Version

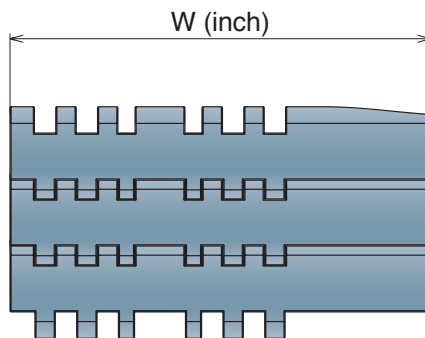
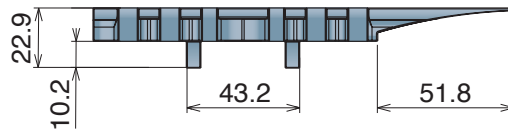

K450 / K750

Series	Material	Width	Version
5346	*	9450	C - R
5346	*	9750	C - R

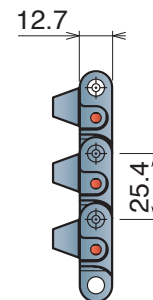

552 FTT - SX Version

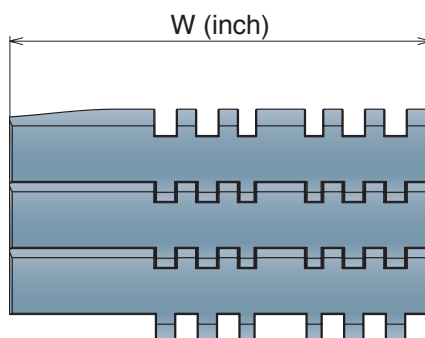
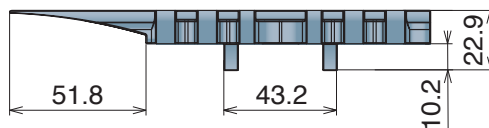

K450 / K750

Series	Material	Width	Version
5346	*	9450	C - L
5346	*	9750	C - L

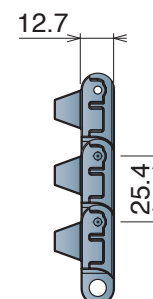

552 PT Open Surface 8% Tappeto Modulare 552 PT, H=12,7 M=3" Modular Belt Series 552 PT, H=12,7 M=3" / Modulare Mattenkette 552 PT, H=12,7 M=3"

CODE STRUCTURE GUIDE			
(Example)			
5342	01	0009	A
Series	*Material	Width	Version

Backflex radius min.: 25 mm

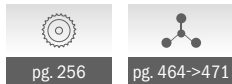

pg. 256

pg. 464->471

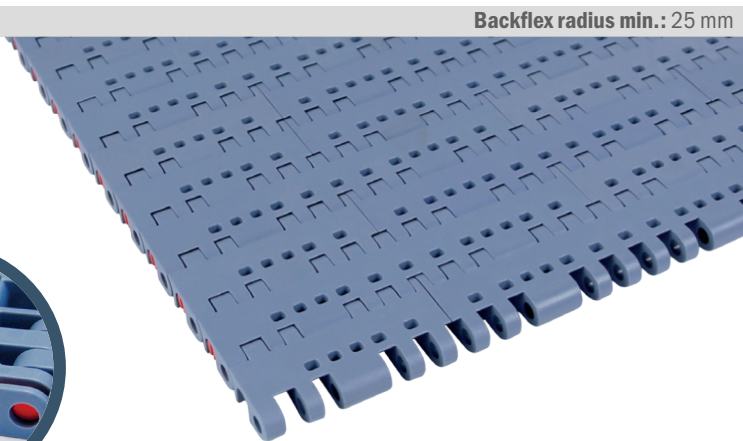
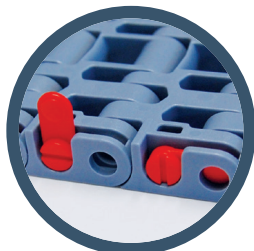

* Material

LFA - Code 01

Low friction Acetal

Max w. load: 41500 N/m
Weight: 13,2 kg/m²
Temp. range dry: -40+80 °C
Temp. range wet: -40+65 °C
Pin material: PBT white

MX - Code 03

Performance PBT

Max w. load: 33500 N/m
Weight: 12,7 kg/m²
Temp. range dry: -40+120 °C
Temp. range wet: -40+60 °C
Pin material: POM grey

DKM - Code 16

Aramide Reinforced Acetal

Max w. load: 41500 N/m
Weight: 13,2 kg/m²
Temp. range dry: -40+80 °C
Temp. range wet: -40+65 °C
Pin material: PBT white

MWX - Code 17

Polyamide Composite

Max w. load: 41500 N/m
Weight: 13,7 kg/m²
Temp. range dry: -40+104 °C
Temp. range wet: NR
Pin material: PBT white

MPX - Code 25

Lubricated Acetal

Max w. load: 41500 N/m
Weight: 13,2 kg/m²
Temp. range dry: -40+80 °C
Temp. range wet: -40+65 °C
Pin material: PBT white

Version A - Standard

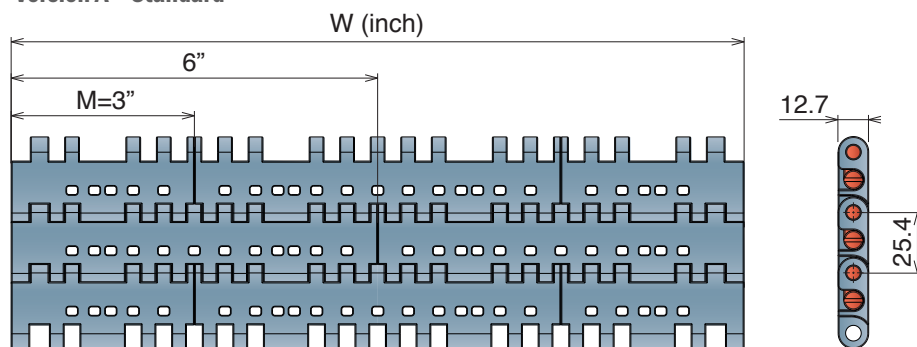

Version A - Standard

Series	Material	Width	Version
5342	*	0009	A
5342	*	0012	A
5342	*	0015	A
5342	*	0018	A
5342	*	0021	A
5342	*	0024	A
5342	*	0027	A
5342	*	0030	A
5342	*	0033	A
5342	*	0036	A
5342	*	0039	A
5342	*	0042	A
5343	*	0045	A
5343	*	0048	A
5343	*	0051	A
5343	*	0054	A

552 PT Open Surface 8% One track Belt

Tappeto Modulare 552 PT, H=12,7 M=3" / Modular Belt Series 552 PT, H=12,7 M=3" / Modulare Mattenkette 552 PT, H=12,7 M=3"

CODE STRUCTURE GUIDE			
(Example)			
5342	01	0003	A
Series	*Material	Width	Version

Backflex radius min.: 25 mm

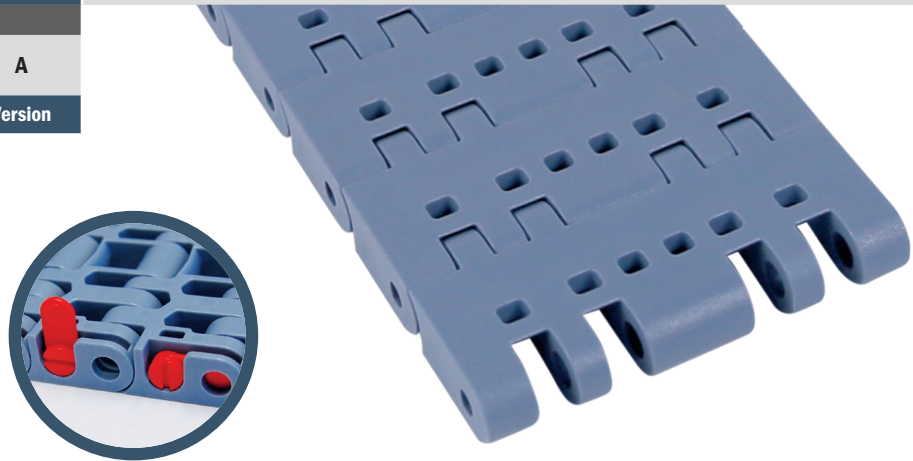
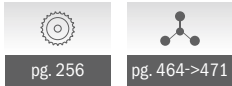

Imperial Size

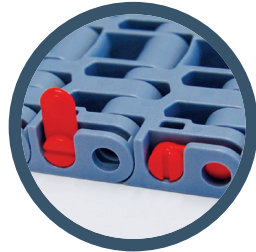

*Material

LFA - Code 01

Low friction Acetal

Max w. load: 41500 N/m
 Weight: 13,2 kg/m²
 Temp. range dry: -40÷80 °C
 Temp. range wet: -40÷65 °C
 Pin material: PBT white

MX - Code 03

Performance PBT

Max w. load: 33500 N/m
 Weight: 12,7 kg/m²
 Temp. range dry: -40÷120 °C
 Temp. range wet: -40÷60 °C
 Pin material: POM grey

DKM - Code 16

Aramide Reinforced Acetal

Max w. load: 41500 N/m
 Weight: 13,2 kg/m²
 Temp. range dry: -40÷80 °C
 Temp. range wet: -40÷65 °C
 Pin material: PBT white

MWX - Code 17

Polyamide Composite

Max w. load: 41500 N/m
 Weight: 13,7 kg/m²
 Temp. range dry: -40÷104 °C
 Temp. range wet: NR
 Pin material: PBT white

MPX - Code 25

Lubricated Acetal

Max w. load: 41500 N/m
 Weight: 13,2 kg/m²
 Temp. range dry: -40÷80 °C
 Temp. range wet: -40÷65 °C
 Pin material: PBT white

Version A - Standard

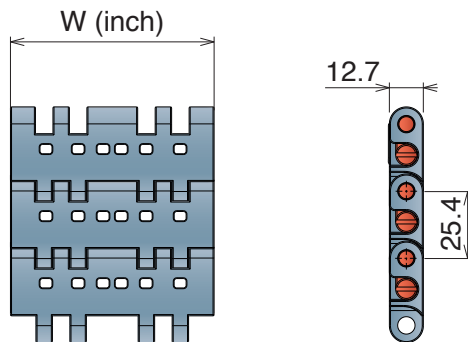

Version C - With 2 Positioner

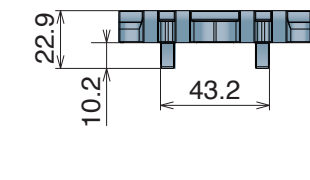

Version A - Standard

Series	Material	Width	Version
5342	*	0003	A
5342	*	0006	A

Version C - With 2 Positioners

Series	Material	Width	Version
5342	*	0003	C
5342	*	0006	C

552 GT

Tappeti modulari / Modular belts / Mattenketten

Imperial Size

552 GT

Tappeto Modulare 552 GT, H=12,7 M=3"

Modular Belt Series 552 GT, H=12,7 M=3" / Modulare Mattenkette 552 GT, H=12,7 M=3"

CODE STRUCTURE GUIDE

(Example)

5343	01	0009	A
Series	*Material	Width	Version

Backflex radius min.: 25 mm



pg. 256



pg. 464->471

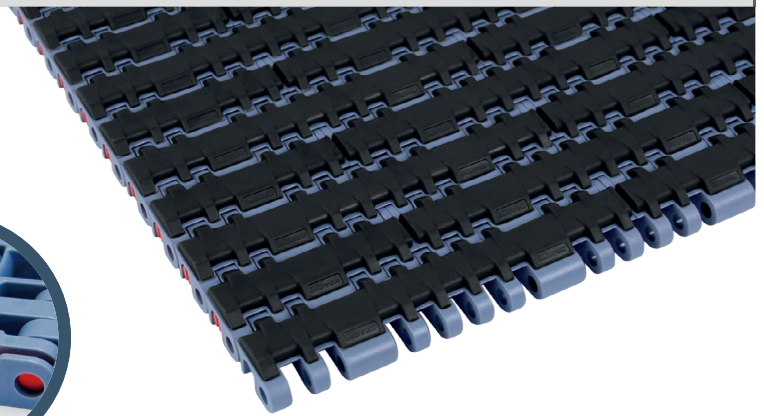
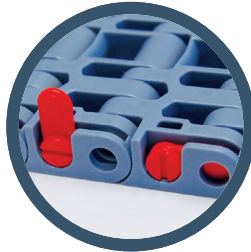

*Material

LFA - Code 01

Low friction Acetal

Max w. load: 41500 N/m
 Weight: 15,5 kg/m²
 Temp. range dry: -40+80 °C
 Temp. range wet: -40+65 °C
 Pin material: PBT white
 Hardness of
 Grip top Rubber: 50 ShA

PP - Code 02

Polypropylene

Max w. load: 27000 N/m
 Weight: 13,5 kg/m²
 Temp. range dry: 4+80 °C
 Temp. range wet: 4+65 °C
 Pin material: PP blu
 Hardness of
 Grip top Rubber: 50 ShA

Version A - Standard

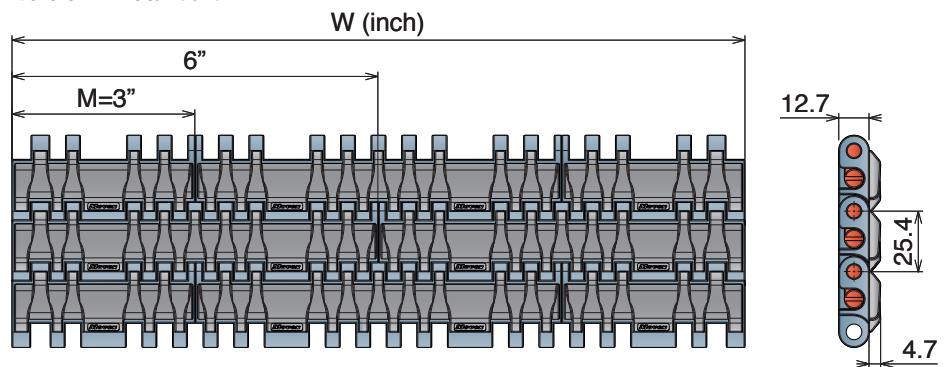

Version A - Standard

Series	Material	Width	Version
5343	*	0009	A
5343	*	0012	A
5343	*	0015	A
5343	*	0018	A
5343	*	0021	A
5343	*	0024	A
5343	*	0027	A
5343	*	0030	A
5343	*	0033	A
5343	*	0036	A
5343	*	0039	A
5343	*	0042	A
5343	*	0045	A
5343	*	0048	A
5343	*	0051	A
5343	*	0054	A



Rubber Thickness 4.7 mm

Tappeti modulari / Modular belts / Mattenketten

552 GT Side indent Tappeto Modulare 552 GT SI, H=12,7 M=3" Modular Belt Series 552 GT SI, H=12,7 M=3" / Modulare Mattenkette 552 GT SI, H=12,7 M=3"

CODE STRUCTURE GUIDE			
(Example)			
5345	01	0009	A
Series	*Material	Width	Version

Backflex radius min.: 25 mm

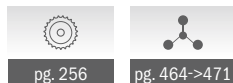

pg. 256

pg. 464->471

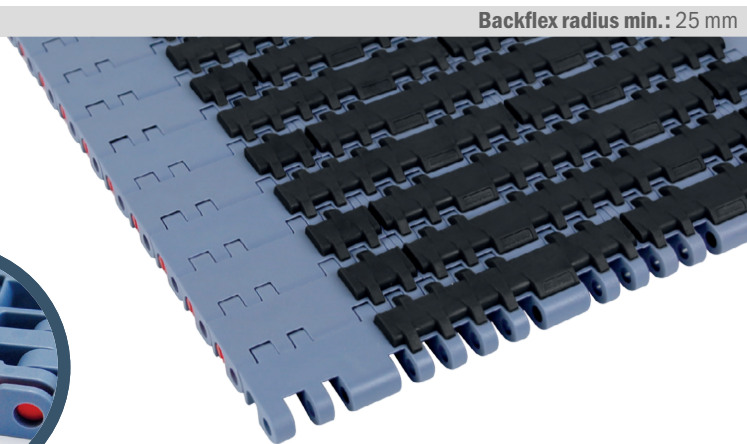
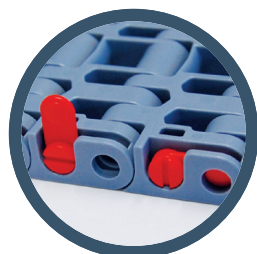

Imperial Size

*Material

LFA - Code 01

Low friction Acetal

Max w. load: 41500 N/m
Weight: 15,5 kg/m²
Temp. range dry: -40÷80 °C
Temp. range wet: -40÷65 °C
Pin material: PBT white
Hardness of
Grip top Rubber: 50 ShA

PP - Code 02

Polypropylene

Max w. load: 27000 N/m
Weight: 13,5 kg/m²
Temp. range dry: 4÷80 °C
Temp. range wet: 4÷65 °C
Pin material: PP blu
Hardness of
Grip top Rubber: 50 ShA

Version A - Standard

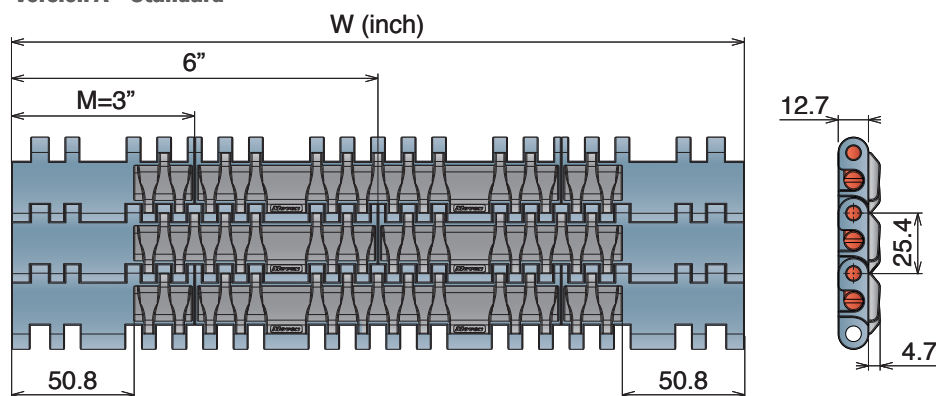

Version A - Standard

Series	Material	Width	Version
5345	*	0009	A
5345	*	0012	A
5345	*	0015	A
5345	*	0018	A
5345	*	0021	A
5345	*	0024	A
5345	*	0027	A
5345	*	0030	A
5345	*	0033	A
5345	*	0036	A
5345	*	0039	A
5345	*	0042	A
5345	*	0045	A
5345	*	0048	A
5345	*	0051	A
5345	*	0054	A



Rubber Thickness 4.7 mm

556

Pitch 25,4 mm
H= 12,7 mm

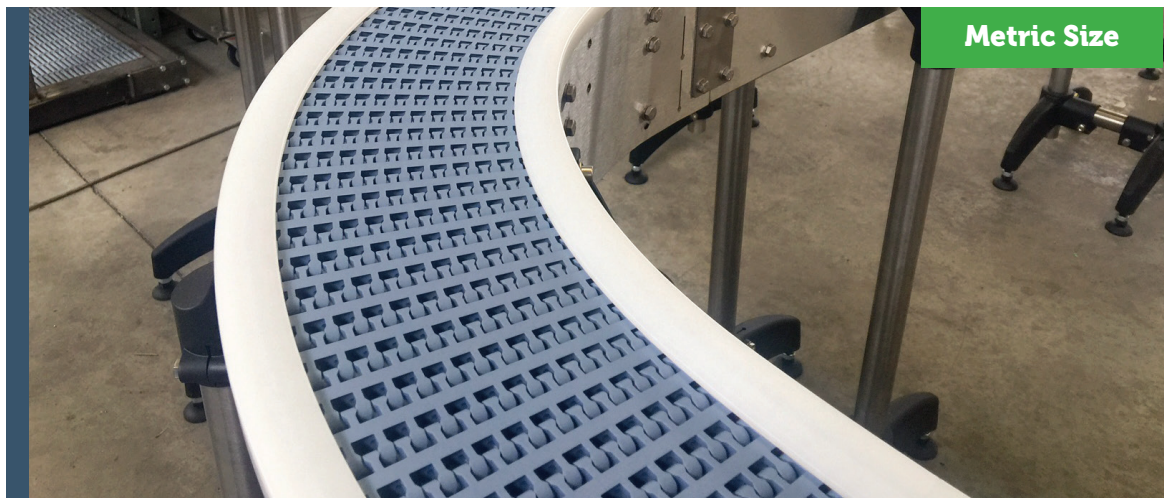

556 FT
556 GT

556 FT

Tappeto Modulare Curvilineo Serie 556, H=12,7 M=3"

Side Flex Modular Belt Series 556, H=12,7 M=3" / Kurvengängige Mattenkette Serie 556, H=12,7 M=3"

CODE STRUCTURE GUIDE			
(Example)			
5431	01	0006	C
Series	*Material	Width	Version

Backflex radius min.: 25 mm

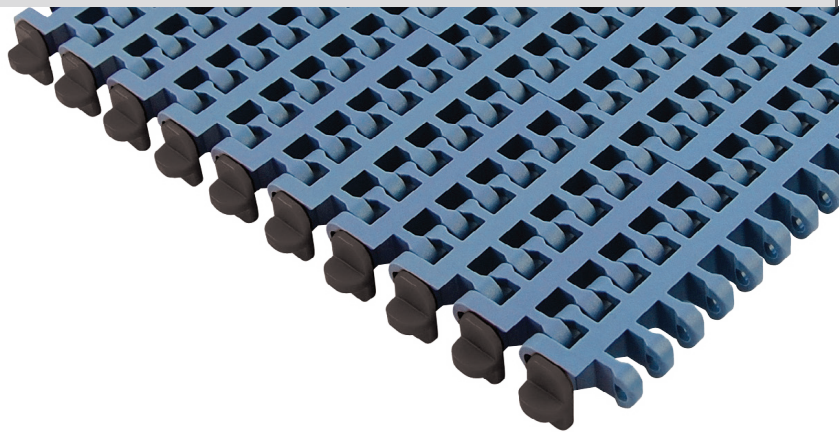

Imperial Size



pg. 257

pg. 464->471

*Material

LFA - Code 01

Low friction Acetal

Max w. load:

Straight: 30000 N/m
Curve: 2000 N

Weight: 7,5 kg/m²

Temp. range dry: -40÷80 °C

Temp. range wet: -40÷65 °C

Pin material: PBT white

MX - Code 03

Performance PBT

Max w. load:

Straight: 24000 N/m
Curve: 1500 N

Weight: 7,2 kg/m²

Temp. range dry: -40÷120 °C

Temp. range wet: -40÷60 °C

Pin material: POM grey

DKM - Code 16

Aramide Reinforced Acetal

Max w. load:

Straight: 30000 N/m
Curve: 2000 N

Weight: 7,5 kg/m²

Temp. range dry: -40÷80 °C

Temp. range wet: -40÷65 °C

Pin material: PBT white

MWX - Code 17

Polyamide Composite

Max w. load:

Straight: 30000 N/m
Curve: 2000 N

Weight: 7,5 kg/m²

Temp. range dry: -40÷104 °C

Temp. range wet: NR

Pin material: PBT white

MPX - Code 25

Lubricated Acetal

Max w. load:

Straight: 30000 N/m
Curve: 2000 N

Weight: 7,5 kg/m²

Temp. range dry: -40÷80 °C

Temp. range wet: -40÷65 °C

Pin material: PBT white

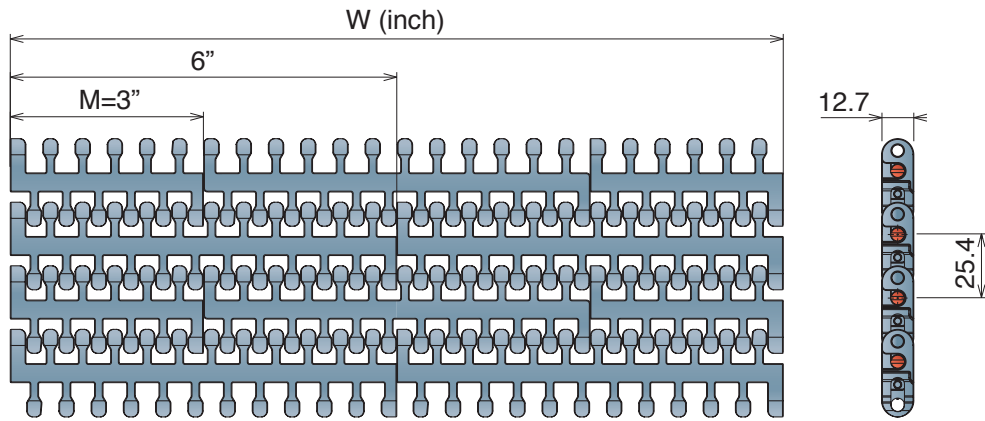

STANDARD

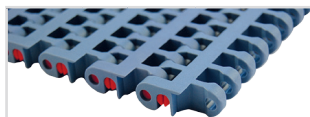

Series	Material	Width	Version	min radius
5431	*	0009	A	435
5431	*	0012	A	580
5431	*	0015	A	725
5431	*	0018	A	890
5431	*	0021	A	1040
5431	*	0024	A	1250

ONE TRACK BELT

Series	Material	Width	Version	min radius
5431	*	0003	A	145
5431	*	0006	A	290

TAB

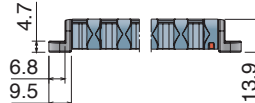
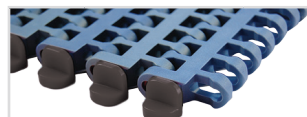

Series	Material	Width	Version	min radius
5431	*	0006	B	290
5431	*	0009	B	435
5431	*	0012	B	580
5431	*	0015	B	725
5431	*	0018	B	890
5431	*	0021	B	1040
5431	*	0024	B	1250

ONE TRACK BELT

Series	Material	Width	Version	min radius
5431	*	0003	B	145
5431	*	0006	B	290

TAB/POSITIONER

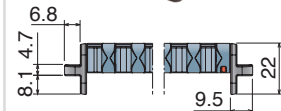
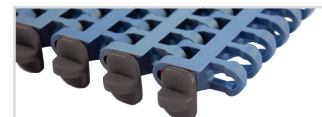

Series	Material	Width	Version	min radius
5431	*	0006	C	290
5431	*	0009	C	435
5431	*	0012	C	580
5431	*	0015	C	725
5431	*	0018	C	890
5431	*	0021	C	1040
5431	*	0024	C	1250

ONE TRACK BELT

Series	Material	Width	Version	min radius
5431	*	0003	C	145
5431	*	0006	C	290

556 GT

Tappeti modulari / Modular belts / Mattenketten

Imperial Size

556 GT

Tappeto Modulare Curvilineo Serie 556 GT, H=12,7 M=3"

Side Flex Modular Belt Series 556 GT, H=12,7 M=3" / Kurvengängige Mattenkette Serie 556 GT, H=12,7 M=3"

CODE STRUCTURE GUIDE			
(Example)			
5433	01	0018	B
Series	*Material	Width	Version

Backflex radius min.: 25 mm

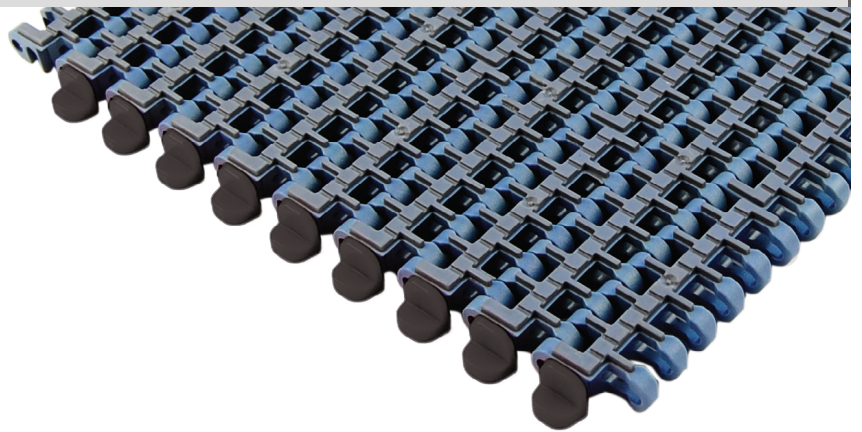

*Material

LFA - Code 01

Low friction Acetal

Max w. load:

Straight: 30000 N/m

Curve: 2000 N

Weight: 7,7 kg/m²

Temp. range dry: -40÷80 °C

Temp. range wet: -40÷65 °C

Pin material: PBT white

Hardness of

Grip top Rubber: 75 ShA

PPB - Code 24

Polypropylene

Standard rubber: 50 ShA

Code: -S

Max w. load:

Straight: 19500 N/m

Curve: 1300 N

Weight: 6,0 kg/m²

Temp. range dry: 4÷65 °C

Temp. range wet: 4÷65 °C

Pin material: PP blu

Hardness of

Grip top Rubber: 50 ShA

MX - Code 03

Performance PBT

Max w. load:

Straight: 28800 N/m

Curve: 1900 N

Weight: 7,8 kg/m²

Temp. range dry: -40÷120 °C

Temp. range wet: -40÷60 °C

Pin material: POM grey

Hardness of

Grip top Rubber: 75 ShA

Available also with

50 ShA Rubber

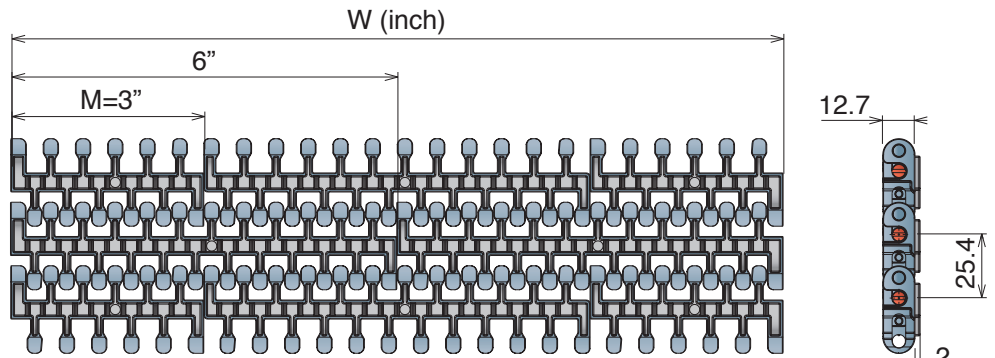

STANDARD

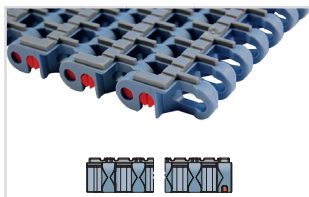

Series	Material	Width	Version	min radius
5433	*	0009	A	435
5433	*	0012	A	580
5433	*	0015	A	725
5433	*	0018	A	890
5433	*	0021	A	1040
5433	*	0024	A	1250

ONE TRACK BELT

Series	Material	Width	Version	min radius
5433	*	0003	A	145
5433	*	0006	A	290

TAB

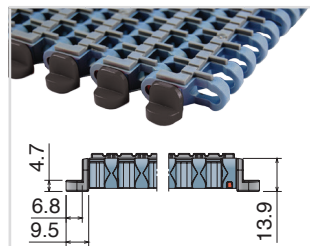

Series	Material	Width	Version	min radius
5433	*	0006	B	290
5433	*	0009	B	435
5433	*	0012	B	580
5433	*	0015	B	725
5433	*	0018	B	890
5433	*	0021	B	1040
5433	*	0024	B	1250

ONE TRACK BELT

Series	Material	Width	Version	min radius
5433	*	0003	B	145
5433	*	0006	B	290

TAB/POSITIONER

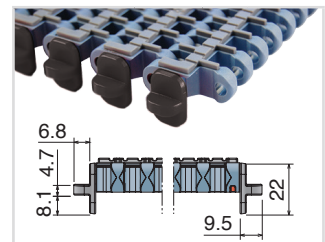

Series	Material	Width	Version	min radius
5433	*	0006	C	290
5433	*	0009	C	435
5433	*	0012	C	580
5433	*	0015	C	725
5433	*	0018	C	890
5433	*	0021	C	1040
5433	*	0024	C	1250

ONE TRACK BELT

Series	Material	Width	Version	min radius
5433	*	0003	C	145
5433	*	0006	C	290

Tappeti modulari / Modular belts / Mattenketten

600

Pitch 31,75 mm
H= 12,7 mm

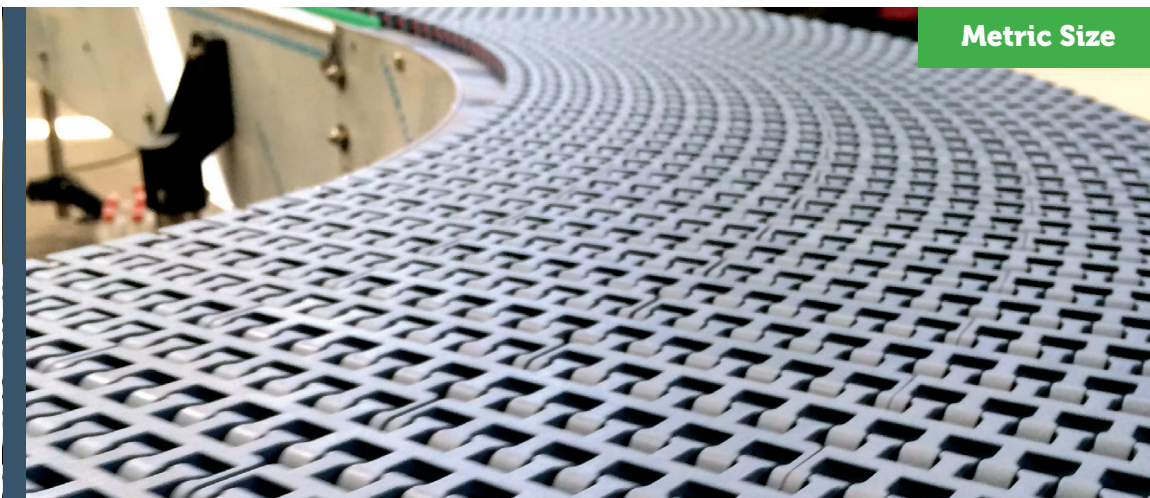

Metric Size

600 Standard

600 Heavy duty

600 Heavy duty with Bearings

600 Small radius

600 Heavy duty/Small radius

**600 Heavy duty/Small radius
with bearing**

600 with pusher

1047 Heavy duty guide

600 Standard

Tappeto Modulare Curvilineo Serie 600, H=12,7 M=85

Side Flex Modular Belt Series 600, H=12,7 M=85 / Kurvengängige Mattenkette Serie 600, H=12,7 M=85

Backflex radius min.: 25 mm

CODE STRUCTURE GUIDE

(Example)

5421	03	0595	A
Series	*Material	Width	Version

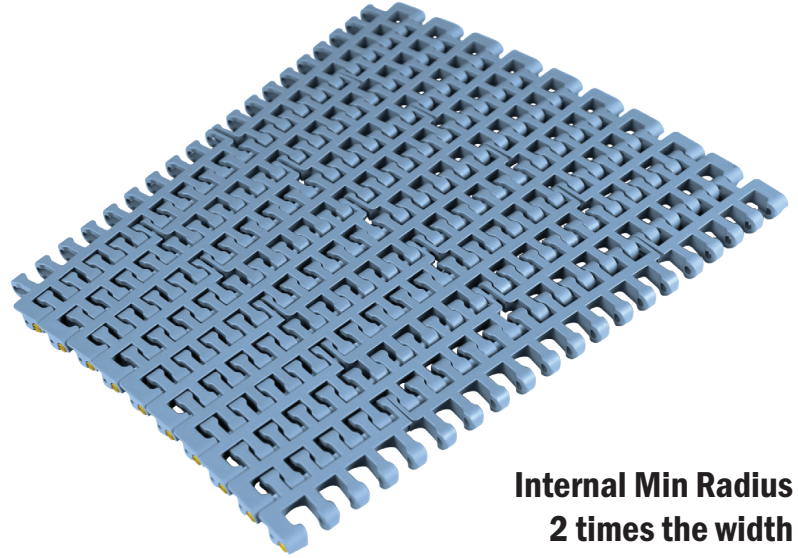
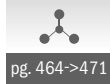

Internal Min Radius
2 times the width

*Material

LFA - Code 01

Low friction Acetal

Max w. load:
Straight 30000 N/m
Curve 2500 N
Weight: 7,7 kg/m²
Temp. range dry: -40+80 °C
Temp. range wet: -40+65 °C
Pin material: PBT white

MX - Code 03

Performance PBT

Max w. load:
Straight 24000 N/m
Curve 2000 N
Weight: 7,5 kg/m²
Temp. range dry: -40+120 °C
Temp. range wet: -40+60 °C
Pin material: POM grey

DKM - Code 16

Aramide Reinforced Acetal

Max w. load:
Straight 30000 N/m
Curve 2500 N
Weight: 7,7 kg/m²
Temp. range dry: -40+80 °C
Temp. range wet: -40+65 °C
Pin material: PBT white

MWX - Code 17

Polyamide Composite

Max w. load:
Straight 30000 N/m
Curve 2500 N
Weight: 8,0 kg/m²
Temp. range dry: -40+104 °C
Temp. range wet: NR
Pin material: PBT white

MPX - Code 25

Lubricated Acetal

Max w. load:
Straight 30000 N/m
Curve 2500 N
Weight: 7,7 kg/m²
Temp. range dry: -40+80 °C
Temp. range wet: -40+65 °C
Pin material: PBT white

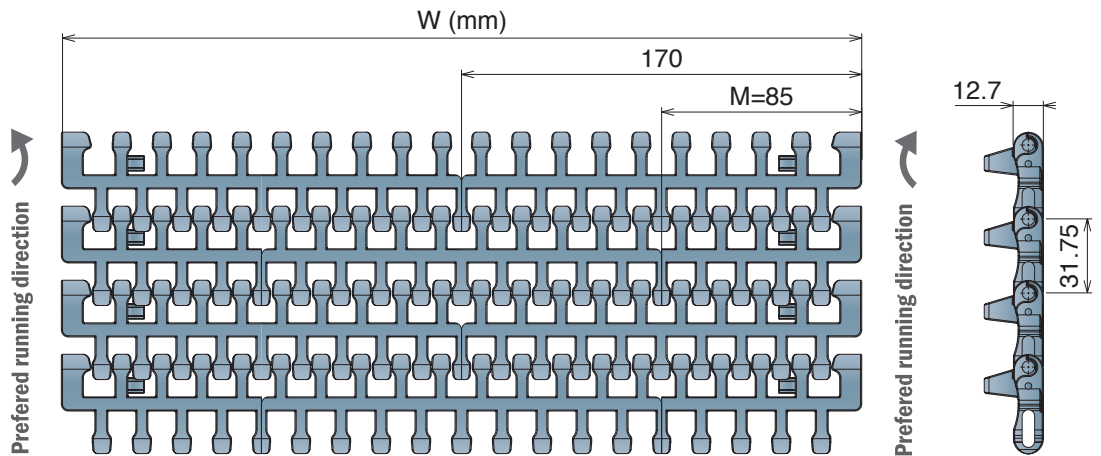

STANDARD



TAB

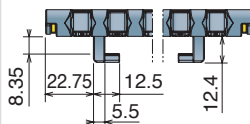

REVERSE TAB

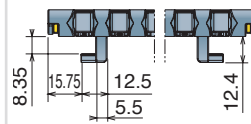

TAB REVERSE TAB

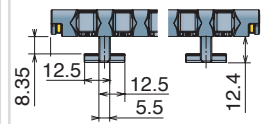

Series	Material	Width	Version	min radius
5421	*	0255	A	510
5421	*	0340	A	680
5421	*	0425	A	850
5421	*	0510	A	1020
5421	*	0595	A	1190
5421	*	0680	A	1360
5421	*	0765	A	1530
5421	*	0850	A	1700
5421	*	0255	B	510
5421	*	0340	B	680
5421	*	0425	B	850
5421	*	0510	B	1020
5421	*	0595	B	1190
5421	*	0680	B	1360
5421	*	0765	B	1530
5421	*	0850	B	1700
5421	*	0255	C	510
5421	*	0340	C	680
5421	*	0425	C	850
5421	*	0510	C	1020
5421	*	0595	C	1190
5421	*	0680	C	1360
5421	*	0765	C	1530
5421	*	0850	C	1700
5421	*	0255	D	510
5421	*	0340	D	680
5421	*	0425	D	850
5421	*	0510	D	1020
5421	*	0595	D	1190
5421	*	0680	D	1360
5421	*	0765	D	1530
5421	*	0850	D	1700

600 Heavy duty

Tappeto Modulare Curvilineo Serie 600, H=12,7 M=85
Side Flex Modular Belt Series 600, H=12,7 M=85 / Kurvengängige Mattenkette Serie 600, H=12,7 M=85

CODE STRUCTURE GUIDE			
(Example)			
5422	03	0340	E
Series	*Material	Width	Version

Backflex radius min.: 25 mm

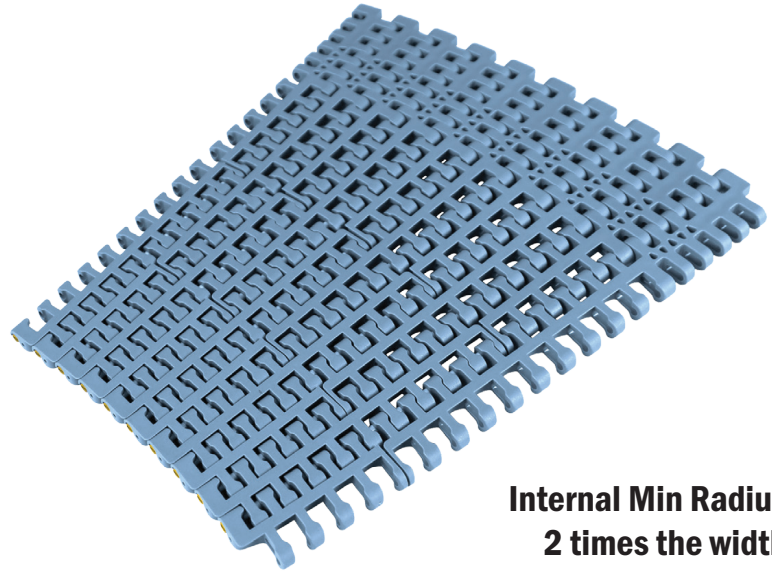

Metric Size

*Material

LFA - Code 01

Low friction Acetal

Max w. load:
Straight 30000 N/m
Curve 3500 N
Weight: 8,3 kg/m²
Temp. range dry: -40+80 °C
Temp. range wet: -40+65 °C
Pin material: PBT white

MX - Code 03

Performance PBT

Max w. load:
Straight 24000 N/m
Curve 3000 N
Weight: 8,0 kg/m²
Temp. range dry: -40+120 °C
Temp. range wet: -40+60 °C
Pin material: POM grey

DKM - Code 16

Aramide Reinforced Acetal

Max w. load:
Straight 30000 N/m
Curve 3500 N
Weight: 8,3 kg/m²
Temp. range dry: -40+80 °C
Temp. range wet: -40+65 °C
Pin material: PBT white

MWX - Code 17

Polyamide Composite

Max w. load:
Straight 30000 N/m
Curve 3500 N
Weight: 8,6 kg/m²
Temp. range dry: -40+104 °C
Temp. range wet: NR
Pin material: PBT white

MPX - Code 25

Lubricated Acetal

Max w. load:
Straight 30000 N/m
Curve 3500 N
Weight: 8,3 kg/m²
Temp. range dry: -40+80 °C
Temp. range wet: -40+65 °C
Pin material: PBT white

Internal Min Radius
2 times the width

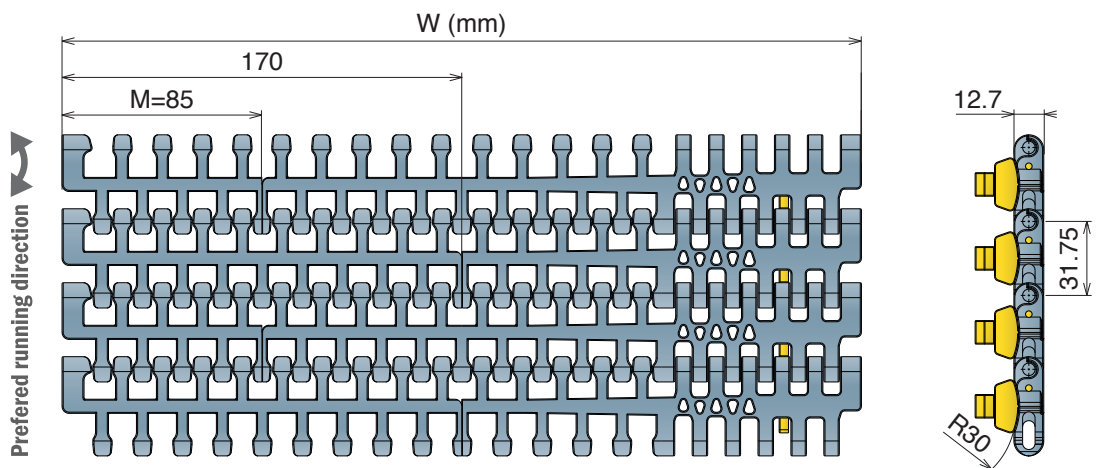

Preferred running direction

STANDARD

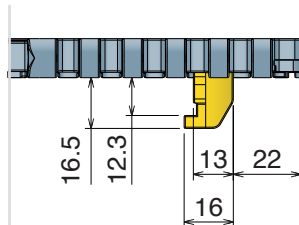

Series	Material	Width	Version	min radius
5422	*	0340	E	680
5422	*	0425	E	850
5422	*	0510	E	1020
5422	*	0595	E	1190
5422	*	0680	E	1360
5422	*	0765	E	1530
5422	*	0850	E	1700

TAB DK Material



600 Heavy duty with Bearings

Tappeti modulari / Modular belts / Mattenketten

Metric Size

600 Heavy duty with Bearings

Tappeto Modulare Curvilineo Serie 600, H=12,7 M=85
Side Flex Modular Belt Series 600, H=12,7 M=85 / Kurvengängige Mattenkette Serie 600, H=12,7 M=85

CODE STRUCTURE GUIDE

(Example)

5422	03	0340	F
Series	*Material	Width	Version

Backflex radius min.: 25 mm

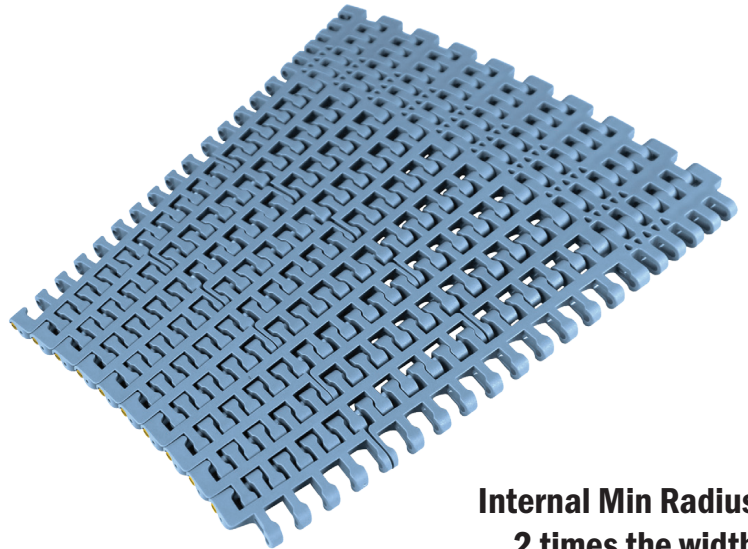
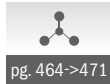

Internal Min Radius
2 times the width

*Material

LFA - Code 01

Low friction Acetal

Max w. load:

Straight 30000 N/m
Curve 3500 N

Weight: 9,0 kg/m²

Temp. range dry: -40+80 °C

Temp. range wet: -40+65 °C

Pin material: PBT white

MX - Code 03

Performance PBT

Max w. load:

Straight 24000 N/m
Curve 3000 N

Weight: 8,7 kg/m²

Temp. range dry: -40+120 °C

Temp. range wet: -40+60 °C

Pin material: POM grey

DKM - Code 16

Aramide Reinforced Acetal

Max w. load:

Straight 30000 N/m
Curve 3500 N

Weight: 9,0 kg/m²

Temp. range dry: -40+80 °C

Temp. range wet: -40+65 °C

Pin material: PBT white

MWX - Code 17

Polyamide Composite

Max w. load:

Straight 30000 N/m
Curve 3500 N

Weight: 9,3 kg/m²

Temp. range dry: -40+104 °C

Temp. range wet: NR

Pin material: PBT white

MPX - Code 25

Lubricated Acetal

Max w. load:

Straight 30000 N/m
Curve 3500 N

Weight: 9,0 kg/m²

Temp. range dry: -40+80 °C

Temp. range wet: -40+65 °C

Pin material: PBT white

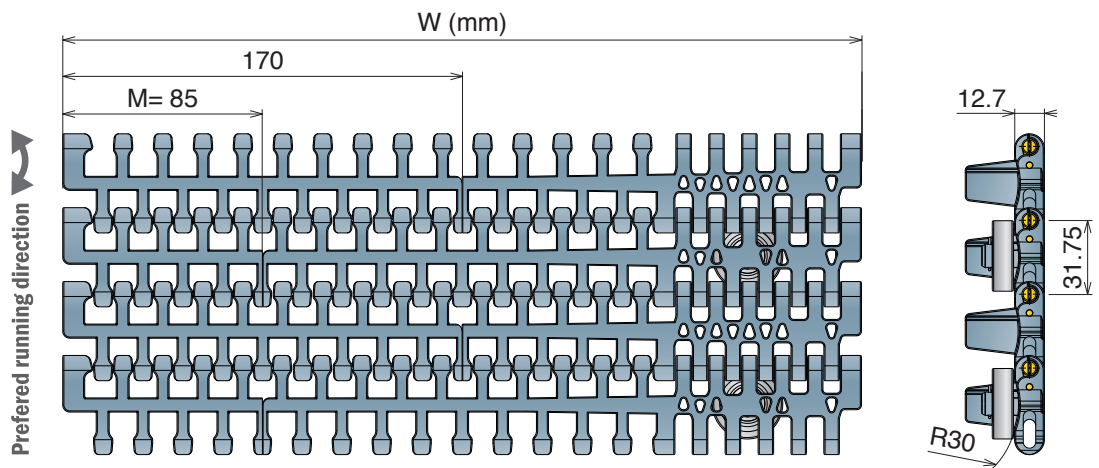

STANDARD

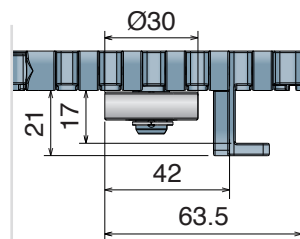

Series	Material	Width	Version	min radius
5422	*	0340	F	680
5422	*	0425	F	850
5422	*	0510	F	1020
5422	*	0595	F	1190
5422	*	0680	F	1360
5422	*	0765	F	1530
5422	*	0850	F	1700

Bearing Zoom

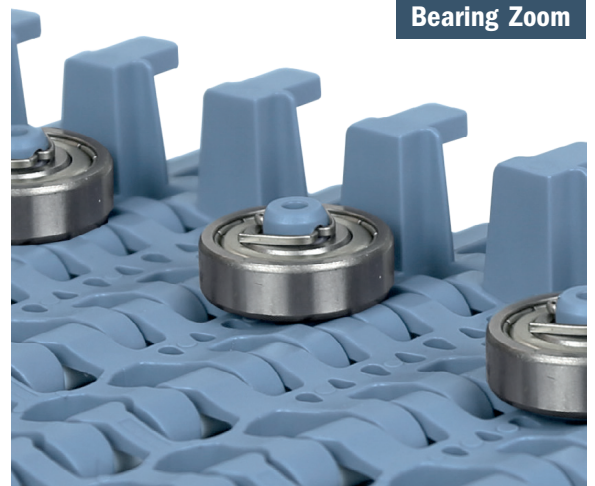

600 Small radius

Tappeto Modulare Curvilineo Serie 600, H=12,7 M=85
Side Flex Modular Belt Series 600, H=12,7 M=85 / Kurvengängige Mattenkette Serie 600, H=12,7 M=85

CODE STRUCTURE GUIDE

(Example)

5423	03	0340	A
Series	*Material	Width	Version

Backflex radius min.: 25 mm



pg. 260



pg. 464->471

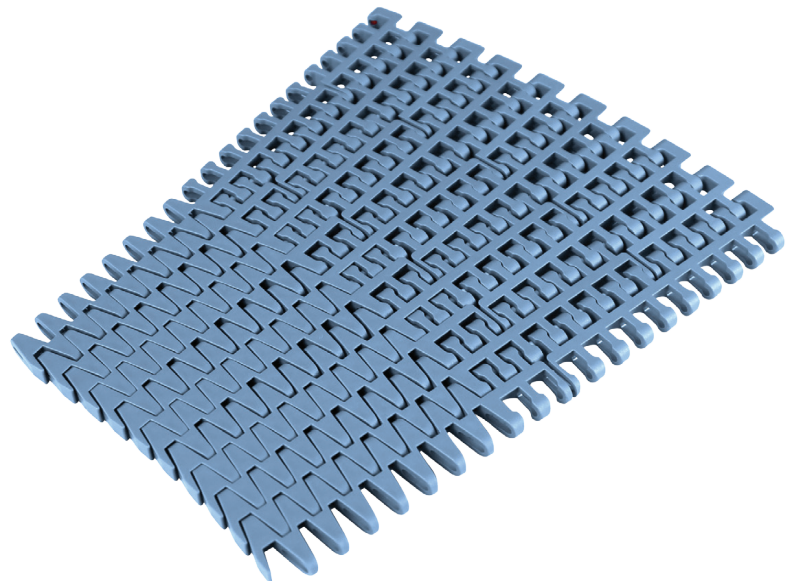

Metric Size

*Material

LFA - Code 01

Low friction Acetal

Max w. load:
Straight 30000 N/m
Curve 2500 N
Weight: 7,0 kg/m²
Temp. range dry: -40+80 °C
Temp. range wet: -40+65 °C
Pin material: PBT white

MX - Code 03

Performance PBT

Max w. load:
Straight 24000 N/m
Curve 2000 N
Weight: 6,8 kg/m²
Temp. range dry: -40+120 °C
Temp. range wet: -40+60 °C
Pin material: POM grey

DKM - Code 16

Aramide Reinforced Acetal

Max w. load:
Straight 30000 N/m
Curve 2500 N
Weight: 7,0 kg/m²
Temp. range dry: -40+80 °C
Temp. range wet: -40+65 °C
Pin material: PBT white

MWX - Code 17

Polyamide Composite

Max w. load:
Straight 30000 N/m
Curve 2500 N
Weight: 7,3 kg/m²
Temp. range dry: -40+104 °C
Temp. range wet: NR
Pin material: PBT white

MPX - Code 25

Lubricated Acetal

Max w. load:
Straight 30000 N/m
Curve 2500 N
Weight: 7,0 kg/m²
Temp. range dry: -40+80 °C
Temp. range wet: -40+65 °C
Pin material: PBT white

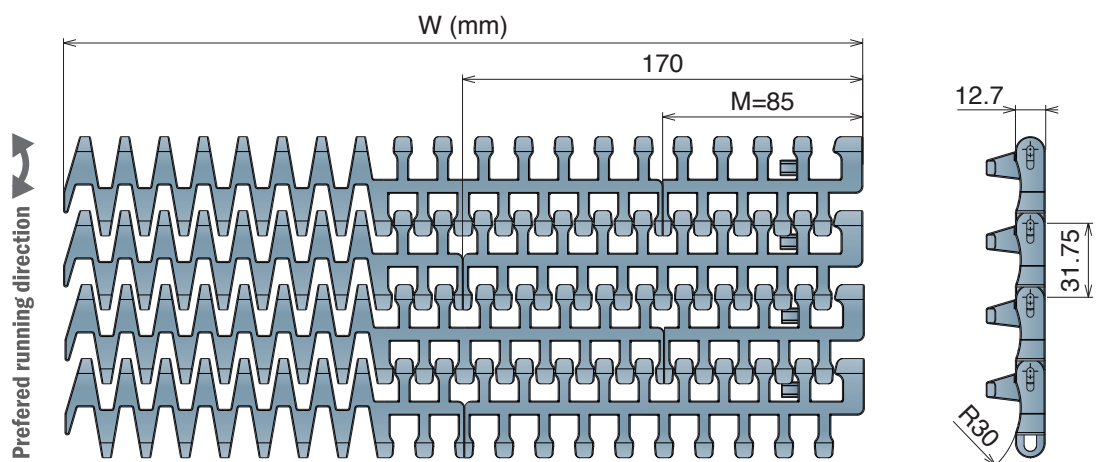

STANDARD

TAB

REVERSE TAB

TAB REVERSE TAB

Series	Material	Width	Version	min radius
5423	* 0340	A	400	
5423	* 0425	A	500	
5423	* 0510	A	600	
5423	* 0595	A	720	
5423	* 0680	A	880	
5423	* 0765	A	1040	
5423	* 0850	A	1200	
5423	* 0340	B	400	
5423	* 0425	B	500	
5423	* 0510	B	600	
5423	* 0595	B	720	
5423	* 0680	B	880	
5423	* 0765	B	1040	
5423	* 0850	B	1200	
5423	* 0340	C	400	
5423	* 0425	C	500	
5423	* 0510	C	600	
5423	* 0595	C	720	
5423	* 0680	C	880	
5423	* 0765	C	1040	
5423	* 0850	C	1200	
5423	* 0340	D	400	
5423	* 0425	D	500	
5423	* 0510	D	600	
5423	* 0595	D	720	
5423	* 0680	D	880	
5423	* 0765	D	1040	
5423	* 0850	D	1200	

600 Heavy duty/Small radius

Tappeti modulari / Modular belts / Mattenketten

600 Heavy duty/Small radius

Tappeto Modulare Curvilineo Serie 600, H=12,7 M=170
Side Flex Modular Belt Series 600, H=12,7 M=170 / Kurvengängige Mattenkette Serie 600, H=12,7 M=170

CODE STRUCTURE GUIDE

(Example)

5424	03	0425	E
Series	*Material	Width	Version

Backflex radius min.: 25 mm

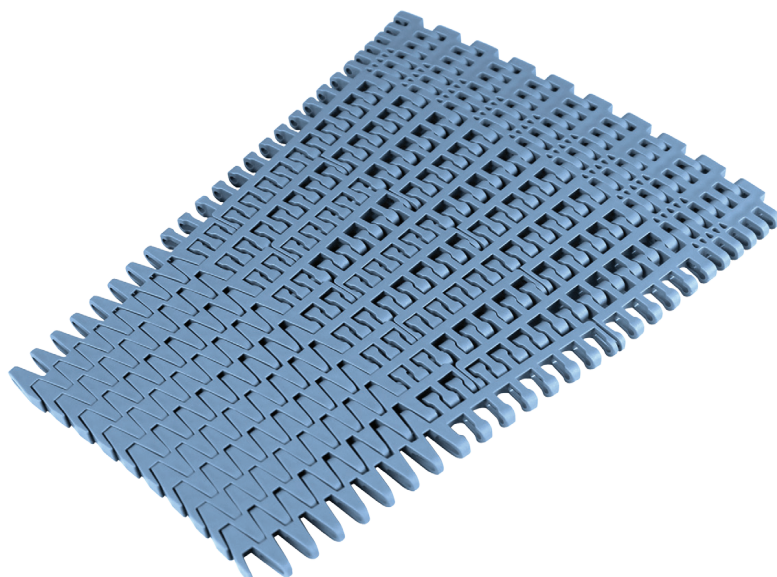
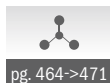

*Material

LFA - Code 01

Low friction Acetal

Max w. load:

Straight 30000 N/m
Curve 3500 N

Weight: 7,5 kg/m²

Temp. range dry: -40+80 °C

Temp. range wet: -40+65 °C

Pin material: PBT white

MX - Code 03

Performance PBT

Max w. load:

Straight 24000 N/m
Curve 3000 N

Weight: 7,3 kg/m²

Temp. range dry: -40+120 °C

Temp. range wet: -40+60 °C

Pin material: POM grey

DKM - Code 16

Aramide Reinforced Acetal

Max w. load:

Straight 30000 N/m
Curve 3500 N

Weight: 7,5 kg/m²

Temp. range dry: -40+80 °C

Temp. range wet: -40+65 °C

Pin material: PBT white

MWX - Code 17

Polyamide Composite

Max w. load:

Straight 30000 N/m
Curve 3500 N

Weight: 7,7 kg/m²

Temp. range dry: -40+104 °C

Temp. range wet: NR

Pin material: PBT white

MPX - Code 25

Lubricated Acetal

Max w. load:

Straight 30000 N/m
Curve 3500 N

Weight: 7,5 kg/m²

Temp. range dry: -40+80 °C

Temp. range wet: -40+65 °C

Pin material: PBT white

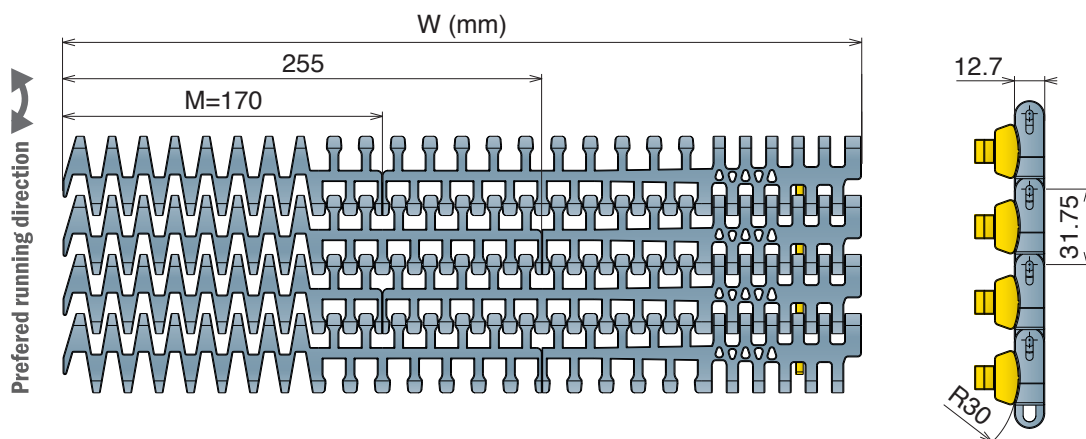

STANDARD

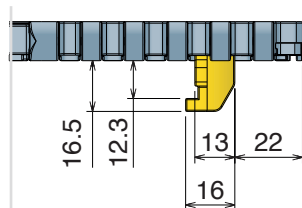

Series	Material	Width	Version	min radius
5424	*	0425	E	500
5424	*	0510	E	600
5424	*	0595	E	720
5424	*	0680	E	880
5424	*	0765	E	1040
5424	*	0850	E	1200

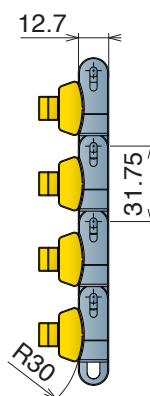

TAB DK Material



600 Heavy duty/Small radius with Bearings

Tappeti modulari / Modular belts / Mattenketten

600 Heavy duty/Small radius with Bearings

Tappeto Curvilineo Serie 600, H=12,7 M=170
Side Flex Modular Belt Series 600, H=12,7 M=170 / Kurvengängige Mattenkette Serie 600, H=12,7 M=170

CODE STRUCTURE GUIDE

(Example)

5424	03	0425	F
Series	*Material	Width	Version

Backflex radius min.: 25 mm



pg. 260



pg. 464->471

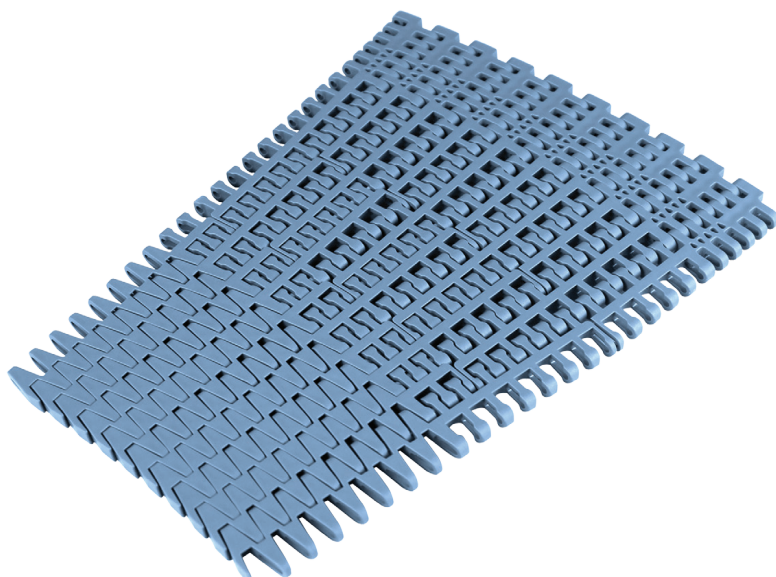

*Material

LFA - Code 01

Low friction Acetal

Max w. load:

Straight 30000 N/m
Curve 3500 N

Weight: 8,5 kg/m²

Temp. range dry: -40÷80 °C

Temp. range wet: -40÷65 °C

Pin material: PBT white

MX - Code 03

Performance PBT

Max w. load:

Straight 24000 N/m
Curve 2000 N

Weight: 8,3 kg/m²

Temp. range dry: -40÷120 °C

Temp. range wet: -40÷60 °C

Pin material: POM grey

DKM - Code 16

Aramide Reinforced Acetal

Max w. load:

Straight 30000 N/m
Curve 2500 N

Weight: 8,5 kg/m²

Temp. range dry: -40÷80 °C

Temp. range wet: -40÷65 °C

Pin material: PBT white

MWX - Code 17

Polyamide Composite

Max w. load:

Straight 30000 N/m
Curve 2500 N

Weight: 9,0 kg/m²

Temp. range dry: -40÷104 °C

Temp. range wet: NR

Pin material: PBT white

MPX - Code 25

Lubricated Acetal

Max w. load:

Straight 30000 N/m
Curve 3500 N

Weight: 8,5 kg/m²

Temp. range dry: -40÷80 °C

Temp. range wet: -40÷65 °C

Pin material: PBT white

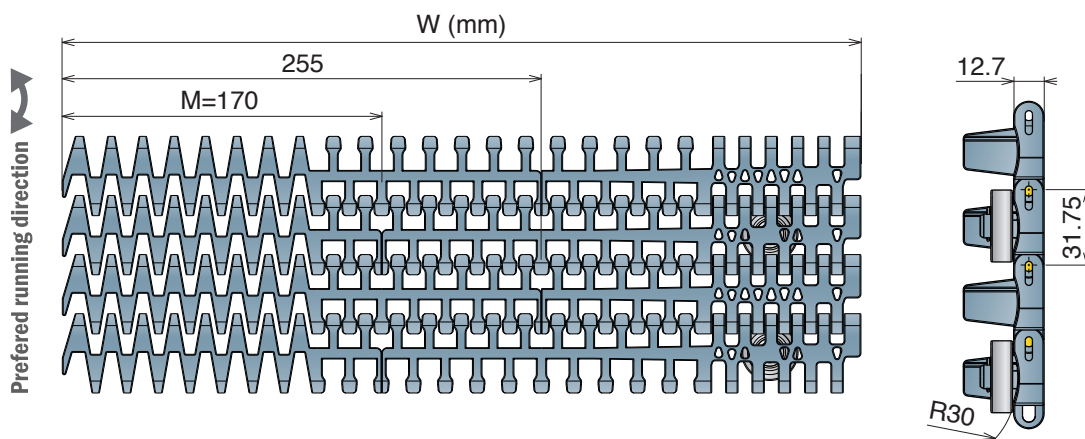

STANDARD

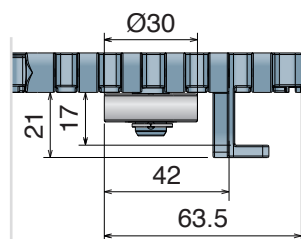

Series	Material	Width	Version	min radius
5424	*	0425	F	850
5424	*	0510	F	1020
5424	*	0595	F	1190
5424	*	0680	F	1360
5424	*	0765	F	1530
5424	*	0850	F	1700

Bearing Zoom



600 with pusher - 1047 Heavy duty guide

Tappeti modulari / Modular belts / Mattenketten

600 with pusher

Tappeto Modulare Curvilineo Serie 600, H=12,7 M=85

Side Flex Modular Belt Series 600, H=12,7 M=85 / Kurvengängige Mattenkette Serie 600, H=12,7 M=85

Metric Size

Consult our engineering department for details.



pg. 260



pg. 464->471

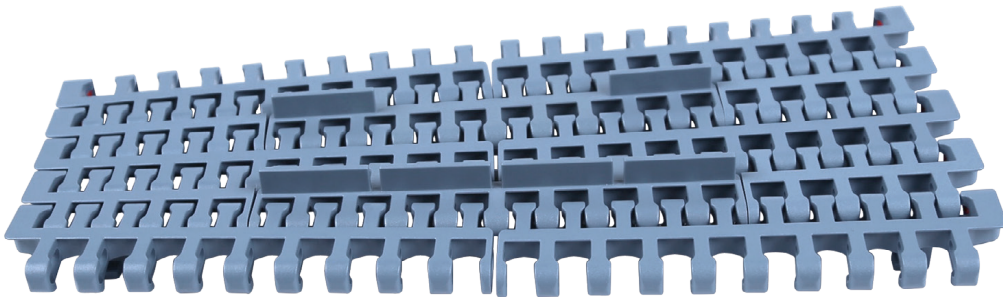

1047

Guida tappeto

Belt side guide / Seitenführung für Mattenkette

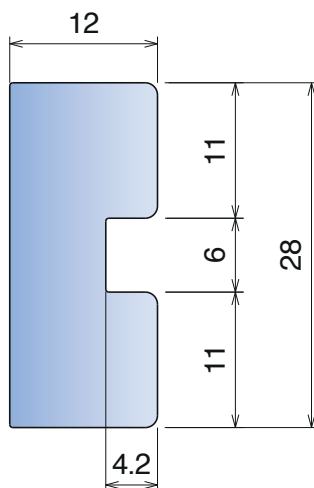
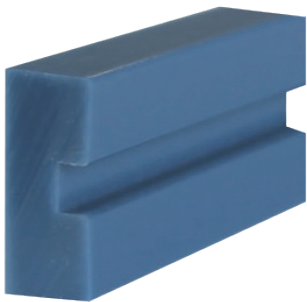

Part	Article-Nr.	Material	Width
1047	104700BC	BluLub	3 m

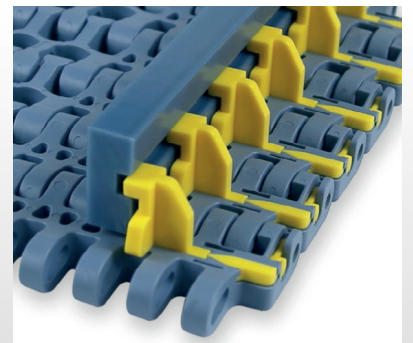

Material: Polyethylene UHMW-PE with molecular density 9,200,000 g/mo.

BluLub® new material with reduced coefficient of friction and higher wear resistance. BluLub complies with the code of Federal Regulations of FDA.
Linear expansion coefficient: $1.1 \times 10^{-4} \text{ } ^\circ\text{F}^{-1}$ ($2 \times 10^{-4} \text{ } ^\circ\text{C}^{-1}$)
Operating temperature: -40 to 176 °F (-40 to +80 °C)

ZER⁵²⁰_{CONTACT} /500

H= 10,1 mm

Pitch 50,8 mm

H= 24 mm



ZERO CONTACT

500 RR

389 Combs

Movex[®]

ZEROCONTACT/500 Series

ZERO CONTACT

Tappeto Modulare Curvilineo Zero Contact™, H=10,1 M=200

Side Flex Modular Belt Zero Contact™, H=10,1 M=200 / Kurvengängige Mattenkette Zero Contact™, H=10,1 M=200

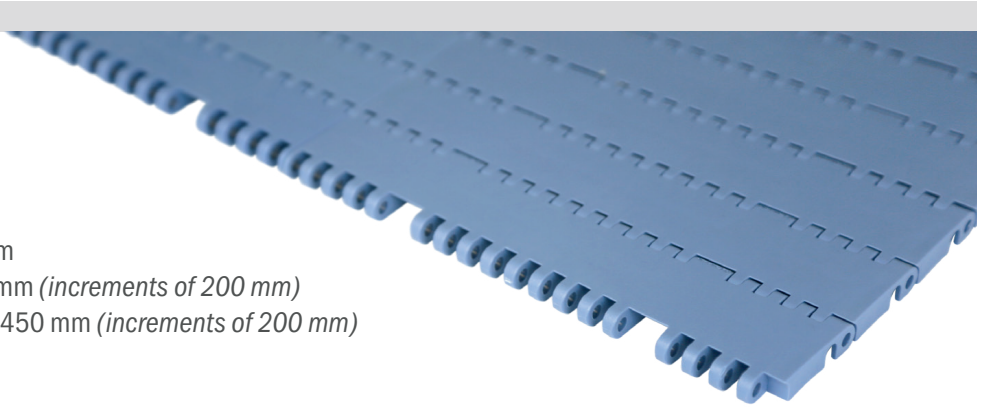
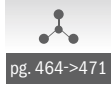

Minimum width available: 200 mm

Maximum width available: 1000 mm (increments of 200 mm)

Rm at first sprocket: 650 mm to 1450 mm (increments of 200 mm)

Row to row angle: 1,33°

Open Area: 0%

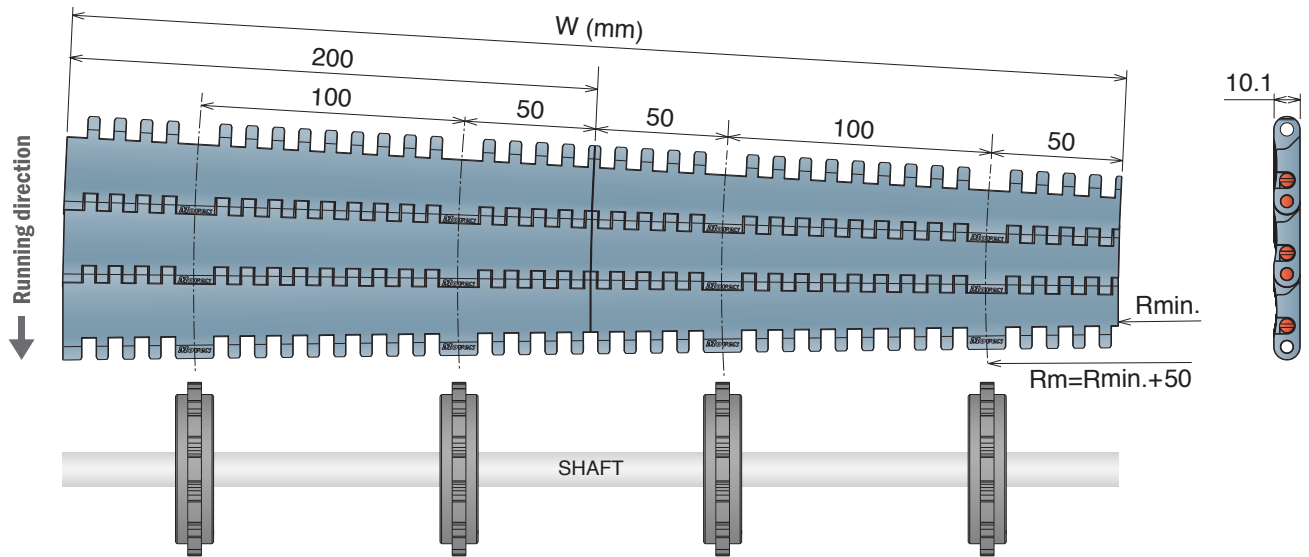

***Material**

LFA

Low friction Acetal

Max w. load: 13500 N/m

Weight: 9,25 kg/m²

Temp. range dry: -40+80 °C

Temp. range wet: -40+65 °C

Part	Belt Width (mm)	Rmin. 600	Rmin. 800	Rmin. 1000	Rmin. 1200	Rmin. 1400
545	200	5451010201A	5451010202A	5451010203A	5451010204A	5451010205A
545	400	5451010401A	5451010402A	5451010403A	5451010404A	-
545	600	5451010601A	5451010602A	5451010603A	-	-
545	800	5451010801A	5451010802A	-	-	-
545	1000	5451011001A	-	-	-	-

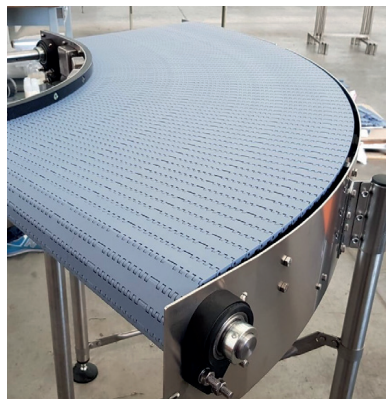

ZERO CONTACT Advantages and features:

New

Design

Simple and Innovative Construction,
Straight Belt eliminated before and after curve.

Features

Speed: Up to 70 meters per minute
Max Belt Pull: Kg. 12000N/m. (belt width)

Space

Less floorspace required.

Product care

Improved product handling,
holding original orientation.

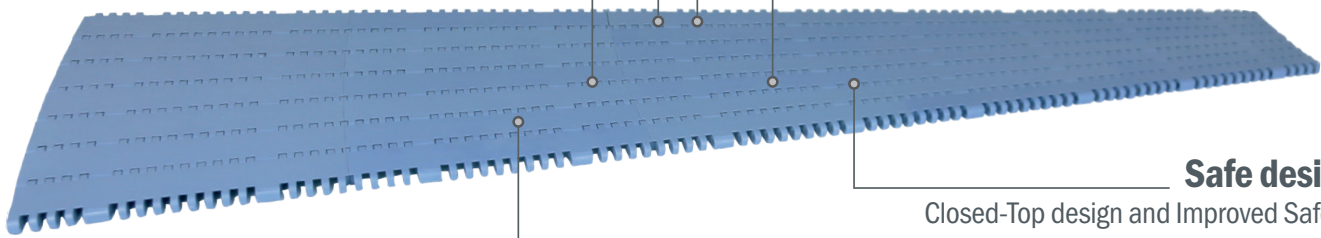

Safe design

Closed-Top design and Improved Safety.

Radius and Pitch

Constant inner radius and reduced pitch

...and Reduced Maintenance Cost!

ZERO CONTACT Split drive sprocket

Ruota traino divisa, fresata / Split drive sprocket, machined / geteiltes Antriebskettenrad gefräst



Part	Article-Nr.	Z-	Bore	R min.	Pitch Diam.	Ext. Diam.	L	S	S2
1624	162401	12	40	600	58,0	61,0	13,6	25,6	53,4
1624	162402			700	66,0	69,0	15,8	29,9	62,3
1624	162403			800	76,0	79,0	18,0	34,2	71,2
1624	162404			900	84,0	86,0	20,2	38,5	80,1
1624	162405			1000	94,0	97,0	22,4	42,8	89,0
1624	162406			1100	102,0	104,0	24,6	47,1	97,9
1624	162407			1200	112,0	114,0	26,8	51,4	104,0
1624	162408			1300	119,0	122,0	29,0	55,7	106,8
1624	162409			1400	130,0	132,0	31,2	60,0	115,7
1624	162410			1500	137,0	140,0	33,4	64,3	124,6

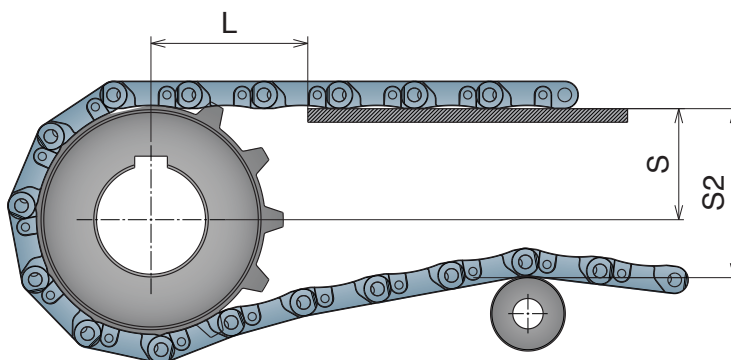

500 RR

Tappeti modulari / Modular belts / Mattenketten

Imperial Size

500 RR

Tappeto Modulare 500 RR
Raised Rib Belt Series 500 RR / Modulare Mattenkette 500 RR

CODE STRUCTURE GUIDE		
(Example)		
1348	11	0090
Series	*Material	Width



pg. 262-263

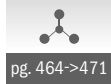

pg. 464->471



*Material

PP - Code 02	PPX - Code 11
Polypropylene	Polypropylene
Max w. load: 30000 N/m	Max w. load: 30000 N/m
Weight: 10,65 kg/m ²	Weight: 10,65 kg/m ²
Temp. range: 4÷104 °C	Temp. range: 4÷104 °C
Pin material: PP grey	Pin material: PP grey

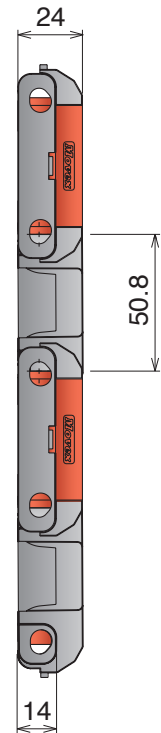
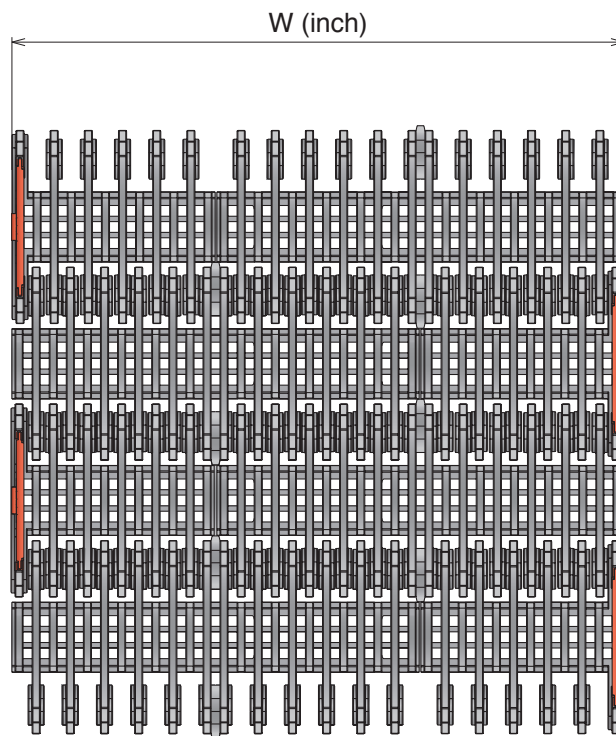

Series	Material	Width	Series	Material	Width
1348	*	0060	1348	*	0093
1348	*	0063	1348	*	0096
1348	*	0066	1348	*	0099
1348	*	0069	1348	*	0102
1348	*	0072	1348	*	0105
1348	*	0075	1348	*	0108
1348	*	0078	1348	*	0111
1348	*	0081	1348	*	0114
1348	*	0084	1348	*	0117
1348	*	0087	1348	*	0120
1348	*	0090			

Tappeti modulari / Modular belts / Mattenketten

389 Pettine
Combs / Fingerplatte



Type A

Part	Article-Nr.
389	38901

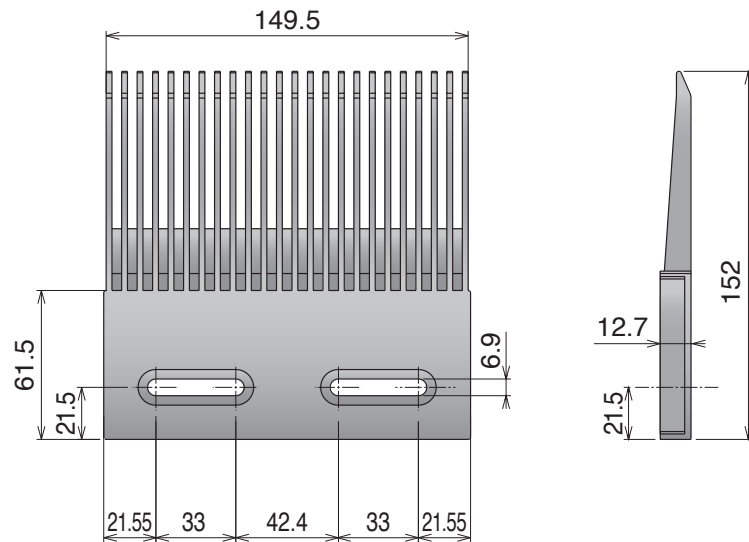

Type B

Part	Article-Nr.
389	38902

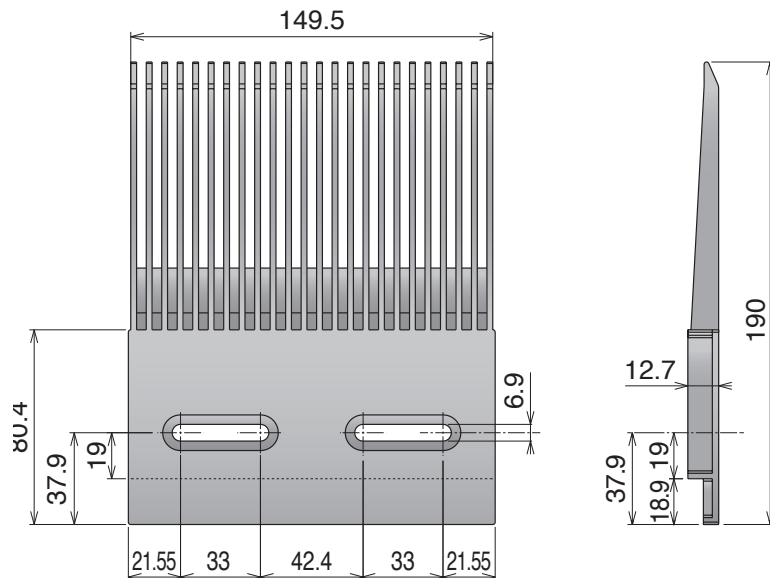

260/261

Pitch 25,4 mm

H= 21 mm / 25 mm / 28,7 mm

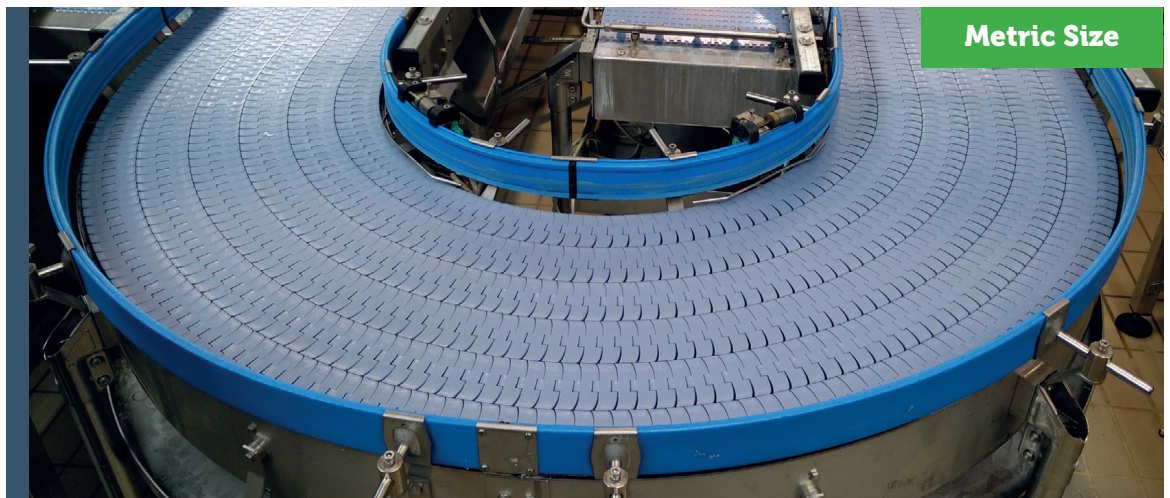

260 M FT
260 M FG
260 TAB

261 M FT
261 TAB

260 M FT

Catena curvilinea
Sideflexing belt/chain / Kurvengängige Mattenkette

Magnetic System

Part	Article-Nr.	Ref.	A	Weight LFA
1151	11510103	260 M K330	83,8	1,75
1151	11510105	260 M K450	114,3	1,95

10 feet 3.048 m	pg. 258-259	pg. 136-142	pg. 464->471
120 links			

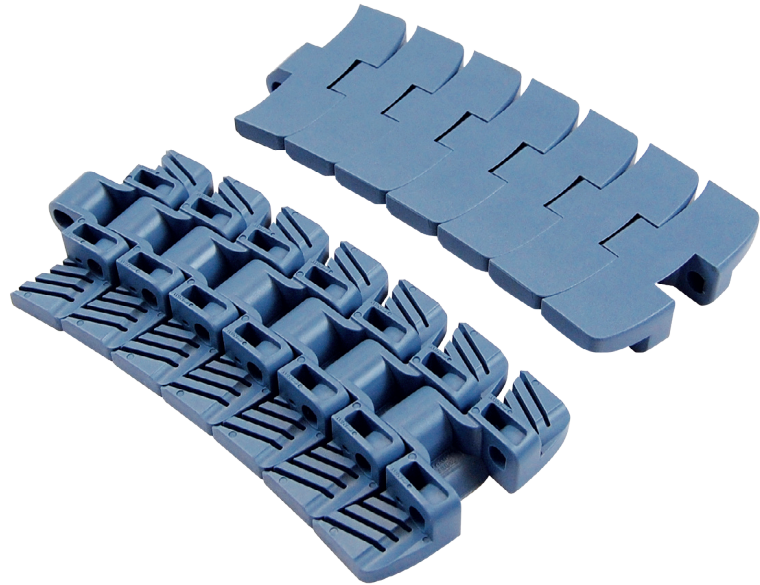

Metric Size

*** Material**

LFA - Code 01

Low friction Acetal

Max w. load: 2000 N/m
Sideflex radius: 500 mm
Pin material: Ferritic SS

MX - Code 03

Performance PBT

Max w. load: 1600 N/m
Sideflex radius: 500 mm
Pin material: Ferritic SS

DKM - Code 16

Aramide Reinforced Acetal

Max w. load: 2000 N/m
Sideflex radius: 500 mm
Pin material: Ferritic SS

MWX - Code 17

Polyamide Composite

Max w. load: 2000 N/m
Sideflex radius: 500 mm
Pin material: Ferritic SS

MPX - Code 25

Lubricated Acetal

Max w. load: 2000 N/m
Sideflex radius: 500 mm
Pin material: Ferritic SS

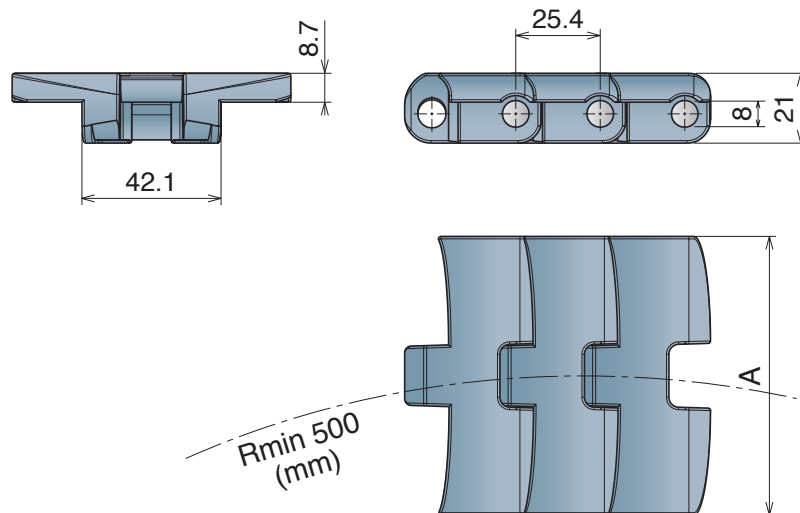

260 M FG

Tappeti modulari / Modular belts / Mattenketten

260 M FG

Catena curvilinea
Sideflexing belt/chain / Kurvengängige Mattenkette

Magnetic System

Metric Size

Part	Article-Nr.	Ref.	A	Weight LFA
1154	11540103	260 M FG K330	83,8	1,50
1154	11540105	260 M FG K450	114,3	1,65

10 feet 3.048 m	pg. 258-259	pg. 136-142	pg. 464->471
120 links			

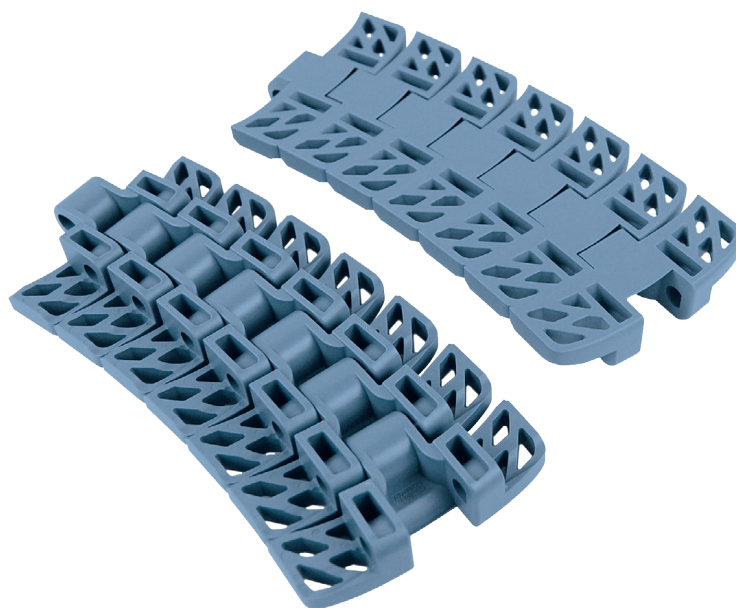

*Material

LFA - Code 01

Low friction Acetal

Max w. load: 2000 N/m
Sideflex radius: 500 mm
Pin material: Ferritic SS

MX - Code 03

Performance PBT

Max w. load: 1600 N/m
Sideflex radius: 500 mm
Pin material: Ferritic SS

DKM - Code 16

Aramide Reinforced Acetal

Max w. load: 2000 N/m
Sideflex radius: 500 mm
Pin material: Ferritic SS

MWX - Code 17

Polyamide Composite

Max w. load: 2000 N/m
Sideflex radius: 500 mm
Pin material: Ferritic SS

MPX - Code 25

Lubricated Acetal

Max w. load: 2000 N/m
Sideflex radius: 500 mm
Pin material: Ferritic SS

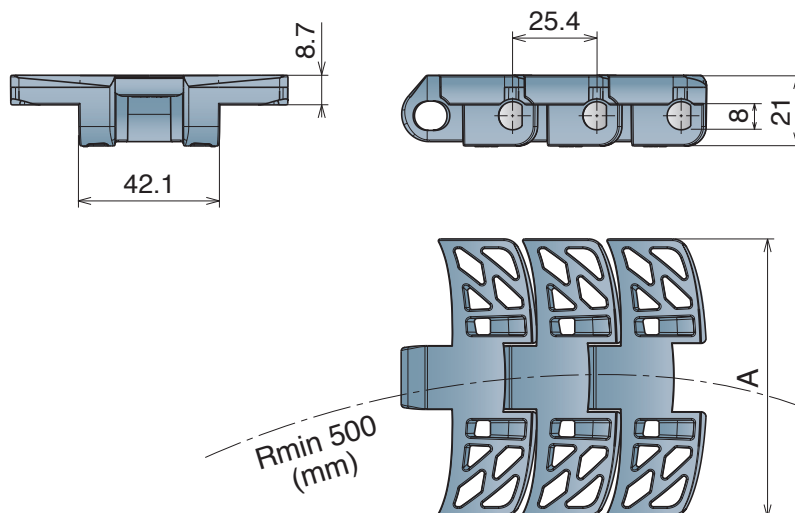

260 TAB

Catena curvilinea
Sideflexing belt/chain / Kurvengängige Mattenkette

Tab System

Part	Article-Nr.	Ref.	A	Weight LFA
1152	11520103	260 TAB K330	83,8	1,85
1152	11520105	260 TAB K450	114,3	2,00

 10 feet 3.048 m	 pg. 258-259	 pg. 157	 pg. 464->471
120 links			



Metric Size

***Material**

LFA - Code 01

Low friction Acetal

Max w. load: 2000 N/m
Sideflex radius: 500 mm
Pin material: Ferritic SS

MX - Code 03

Performance PBT

Max w. load: 1600 N/m
Sideflex radius: 500 mm
Pin material: Ferritic SS

DKM - Code 16

Aramide Reinforced Acetal

Max w. load: 2000 N/m
Sideflex radius: 500 mm
Pin material: Ferritic SS

MWX - Code 17

Polyamide Composite

Max w. load: 2000 N/m
Sideflex radius: 500 mm
Pin material: Ferritic SS

MPX - Code 25

Lubricated Acetal

Max w. load: 2000 N/m
Sideflex radius: 500 mm
Pin material: Ferritic SS

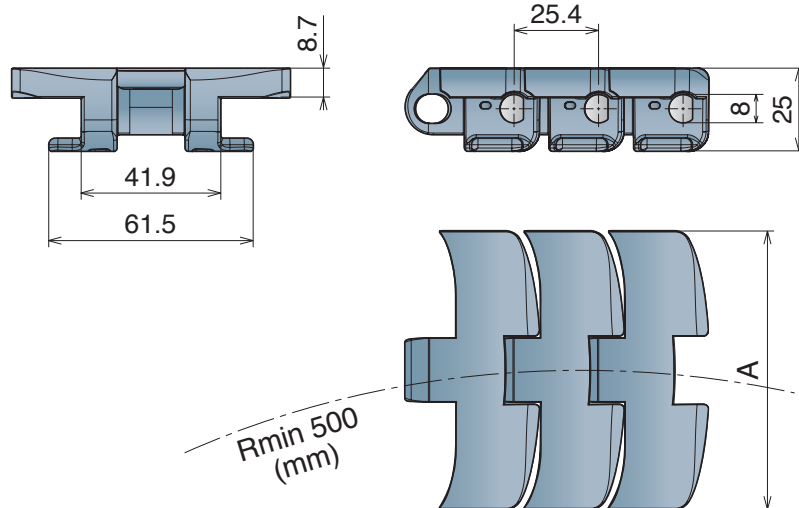

261 M FT

Tappeti modulari / Modular belts / Mattenketten

261 M FT

Catena curvilinea
Sideflexing belt/chain / Kurvengängige Mattenkette

Magnetic System

Metric Size

Part	Article-Nr.	Ref.	A	Weight LFA
1153	11530103	261 M K330	83,8	2,10
1153	11530105	261 M K450	114,3	2,26



10 feet
3.048 m



120 links



pg. 258-259



pg. 143-149



pg. 464->471

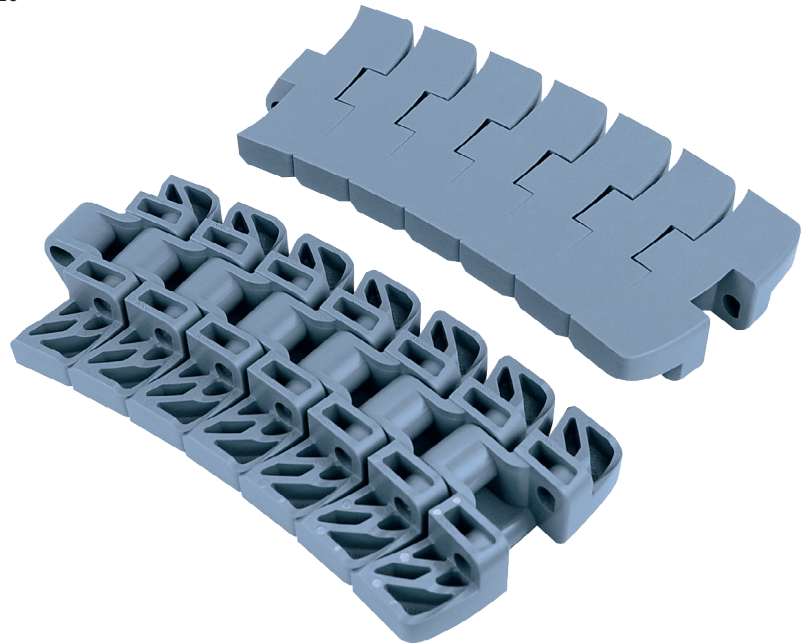

*Material

LFA - Code 01

Low friction Acetal

Max w. load: 2000 N/m
Sideflex radius: 500 mm
Pin material: Ferritic SS

MX - Code 03

Performance PBT

Max w. load: 1600 N/m
Sideflex radius: 500 mm
Pin material: Ferritic SS

DKM - Code 16

Aramide Reinforced Acetal

Max w. load: 2000 N/m
Sideflex radius: 500 mm
Pin material: Ferritic SS

MWX - Code 17

Polyamide Composite

Max w. load: 2000 N/m
Sideflex radius: 500 mm
Pin material: Ferritic SS

MPX - Code 25

Lubricated Acetal

Max w. load: 2000 N/m
Sideflex radius: 500 mm
Pin material: Ferritic SS

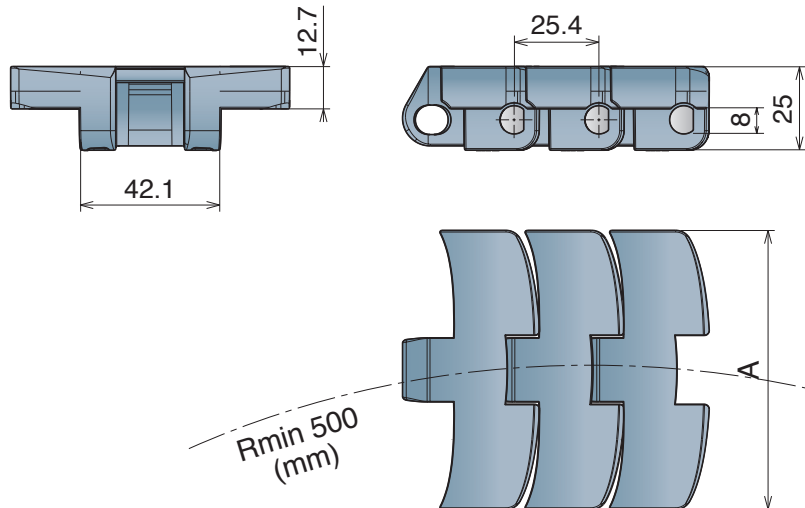





261 TAB

Catena curvilinea
Sideflexing belt/chain / Kurvengängige Mattenkette

Tab System

Part	Article-Nr.	Ref.	A	Weight LFA
1190	11900103	261 TAB K330	83,8	1,85
1190	11900105	261 TAB K450	114,3	2,00

 10 feet 3.048 m	 pg. 258-259	 pg. 157	 pg. 464->471
120 links			

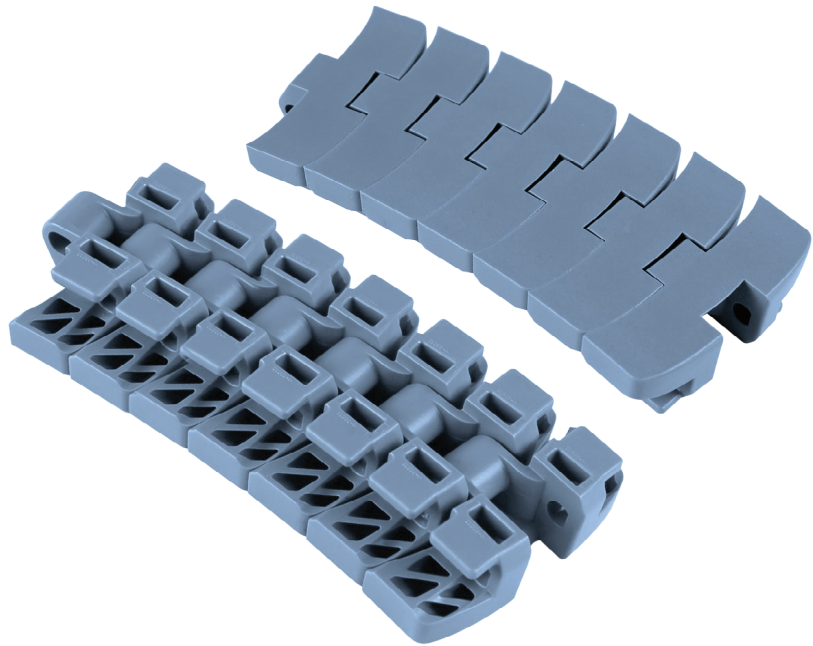

*Material

LFA - Code 01

Low friction Acetal

Max w. load: 2000 N/m
Sideflex radius: 500 mm
Pin material: Ferritic SS

MX - Code 03

Performance PBT

Max w. load: 1600 N/m
Sideflex radius: 500 mm
Pin material: Ferritic SS

DKM - Code 16

Aramide Reinforced Acetal

Max w. load: 2000 N/m
Sideflex radius: 500 mm
Pin material: Ferritic SS

MWX - Code 17

Polyamide Composite

Max w. load: 2000 N/m
Sideflex radius: 500 mm
Pin material: Ferritic SS

MPX - Code 25

Lubricated Acetal

Max w. load: 2000 N/m
Sideflex radius: 500 mm
Pin material: Ferritic SS

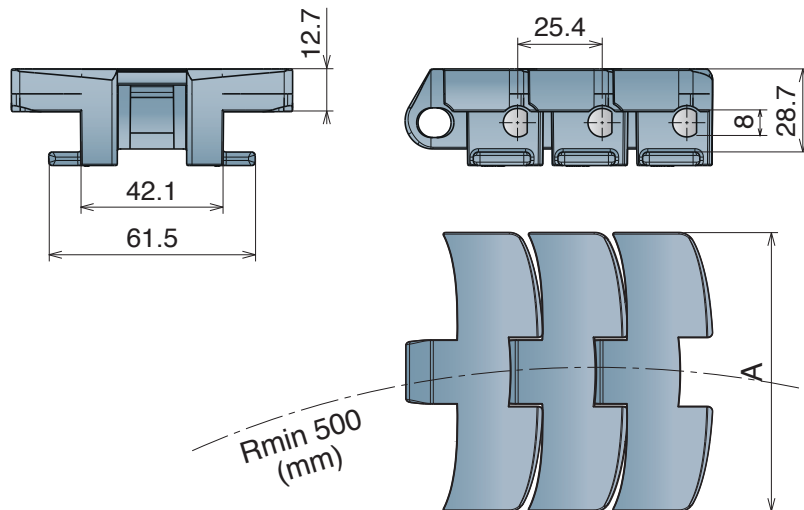

Metric Size